

Operation Manual of Solar Controller SR658for Split Solar System



i Read the instruction carefully please before operation!

Contents

1. Safety information	4
1.1 Installation and commissioning	4
1.2 About this manual.....	4
1.3 Liability waiver	4
1.4 Important information	5
1.5 Signal description.....	5
1.6 HMI button	5
1.7 Meaning of icons appeared on the screen	6
2. Overview	6
2.1 Controller introduction	6
2.2 Delivery list	7
2.3 Technical data	7
3. Installation	8
3.1 Mounting controller.....	8
3.2 Wiring connection.....	8
3.3 Terminal connection	9
3.4 TF (MicroSD) Card	12
4. System introduction.....	13
4.1 Overview of the available systems.....	13
4.2 Description of 19 systems	15
System 1: Standard solar system with 1 tank, 1 collector field.....	15
System 2: Solar system with 1 tank, 1 collector field, 3-ways valve for tank loading in layers	16
System 3: Solar system with 1 collector field, 2 tanks and thermal energy transferring between 2 tanks.....	17
System 4: Standard solar system with heat exchanger control logic	18
System 5: Solar system with 1 collector field, 2 tanks, pump -logic control	20
System 6: Solar system with 1 collector field, 1 tank, valve logic control	21
System 7: Solar system with east/west collector fields, 1 tank	22
System 8: Solar system with east/west collector field, valve logic control, loading in layers	23
System 9: Solar system with east/west collector fields, 2 tanks, valve logic control	24
System 10: Solar system with east/west collector fields, 1 tank, loading the heating return	26
System 11: Solar system with 1 collector field, 1 tank, loading the heating return	27
System 12: Solar system with 1 collector field, 2 tanks, valve logic, heating return loading.....	28

System 13: Solar system with 1collector field, 2 tanks, thermal energy transferring	29
System 14: Solar system with 1 collector field, swimming pool heating	31
System 15: Solar system with 1 collector field, heat exchanger and swimming pool heating.....	32
System 16: Solar system with 1 collector field,1 tank, swimming pool, valve and heat exchanger control.....	33
System 17: System with 1 tank and solid fuel boiler.....	35
System 18: System with 2 tanks, thermal energy transferring and solid fuel boiler	36
System 19: System with 1 tank, heating return and solid fuel boiler.....	37
4.3 Commissioning.....	38
5. Functions and options.....	39
5.1Overview of menu structure	39
5.2 Menu operation description	39
5.3 Check value	40
5.4 Quick trigger function of back-up heating and circuit pump	40
6. Menu function and parameter set (for user)	41
(1) Date(Time/ Date set)	41
(2) THET Timed back-up heating	42
(3) CIRC DHWcircuit pump controlled by temperature in three time - sections / flow switcher	46
7. Function operation and parameter setting (expertise).....	52
(4) PRSWD password	52
(5) SYS system selection	53
(6) (7) LOAD/LOAD2 Tank heating set.....	53
(8) (9) COL/COL2 Collector function	56
(10) PINTV Swimming pool function	62
(11) PUMP Pump control mode	64
(12) LLOGI Tank priority logic	66
(13) COOL Cooling function	70
(14) HEATX Energy exchange between tanks	74
(15) RPH Heating return pipe preheat	76
(16) DLHTX Thermal energy transferring between 2 tanks	78
(17) EXHX External heat exchanger control function	79
(18) SFB Solid fuel boiler function.....	82

(19) AUXAuxiliaryfunctions	84
(20) MAN Manual mode	88
(21) BLPR Block protection function	89
(22) OTDI Thermal disinfection function	90
(23) OPARR Parallel relay.....	92
(24) OHQMHeat quantity measurement.....	93
(25) FS Flow meter selection and flow monitor	96
(26) UNIT Unit switch	98
(27) OSDC (SD card)	99
(28) RET Reset	101
(29) PASS Password set.....	102
8. Holiday function.....	102
9. Software of controller update.....	103
10. Protection function	104
10.1 Screen protection.....	104
10.2 Trouble protection	104
10.3 Trouble checking	104
11. Quality Guarantee.....	110
12. Accessories.....	110

1. Safety information

1.1 Installation and commissioning

- When laying wires, please ensure that no damage occurs to any of the constructional fire safety measures presented in the building.
- The controller should not be installed in rooms where easily inflammable gas mixtures are present or may occur.
- The permissible environmental conditions can't be exceeded at the site of installation.
- Before connecting the device, please make sure that the power supply matches the specifications that controller requires.
- All devices connected to the controller must conform to the technical specifications of the controller.
- All operations on an open controller are only to be conducted cleared from the power supply. All safety regulations for working on the power supply are valid.
- Connecting and / or all operation that require opening the controller (e.g. changing the fuse) are only conducted by specialists.

1.2 About this manual

This manual describes the installation, functions and operation of a solar controller. When installing the remaining components e.g. the solar collectors and the tank unit, please ensure to observe the appropriate installation instructions provided by each manufacturer. Installation, electrical connection, commissioning and maintenance of the device may only be performed by trained professional person. The professional person must be familiar with this manual and follow the instructions contained herein.

1.3 Liability waiver

The manufacturer can't monitor the compliance with these instructions or the circumstances and methods used for installation, operation, utilization and maintenance of this controller. Improper installation can cause damages to material and person. This is the reason why we do not take over responsibility and liability for losses, damages or cost that might arise due to improper installation, operation or wrong utilization and maintenance or that occurs in some connection with the above-mentioned. Moreover, we do not take over liability for patent infringements or infringements – occurring relating to the use of this controller on the third parties' rights. The manufacturer preserves the right to put changes to product, technical data or installation and operation instructions without prior notice. As soon as it becomes evident that safe operation is no longer possible (e.g. visible damage). Please immediate take the device out of operation. Note: ensure that the device can't be accidentally placed into

operation.

1.4 Important information

We have carefully checked the text and pictures of this manual and provided the best of our knowledge and ideas, however inevitable errors may exist. Please note that we cannot guarantee that this manual is given in the integrity of image and text, they are just some examples, and they apply only to our own system. Incorrect, incomplete and erroneous information and the resulting damage we do not take responsibility.

1.5 Signal description



Safety indication: Safety instructions in the text are marked with a warning triangle.

They indicate measures which can lead to injury of person or safety risks.

Operation steps: small triangle “▶” is used to indicate operation step.



Notes: Contains important information about operation or functions.

1.6 HMI button

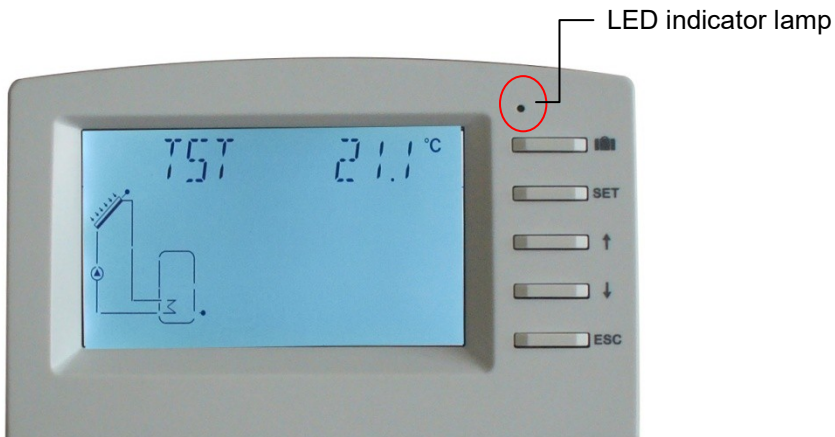

















➤ Controller is operated with the 5 buttons besides the screen

- “” holiday button
- “SET” button: confirm / selection
- “↑” upwards button: increase the value
- “↓” downwards button: reduce the value
- “ESC” button return/ exit: return to the previous menu



Note: TST is temperature of tank 1(on screen)

1.7 Meaning of icons appeared on the screen

Icon Meaning	Code	Icon is lighting	Icon is blinking
Exceed the maximum temperature of tank	SMX		
Running of tank emergency shutdown function	LEM		 + 
Running of collector emergency shutdown function	CEM		
Running of collector cooling function	CMAX		
Running of tank cooling function	OSTC		
Running of system cooling function	OSYC		
Activating of anti-freezing function			
Running of anti-freezing function	CFRO		 + 
Activating of collector minimum temperature function	CMIN		
Error of temperature sensor	T ----		
Error of flow sensor	L/M ----		 + 

2. Overview

2.1 Controller introduction

- LED large screen display
- 6 * relay outputs
- 1 * low voltage relay output for boiler on/off control
- 8 * sensor inputs
- 1 * Input for Grundfos Direct Sensor TM (VFS)
- 1 * Input for (FRT)rotary blade electronic flow meter
- 3 * Variable frequency PWM outputs for the speed control of the high efficiency pump
- Data saved on the TF card (Micro SD)



- 19 systems for choose

2.2 Delivery list

- 1 * SR658 controller
- 1 * user manual
- 2 * P1000 temperature sensor ($\phi 6 \times 50$ mm, cable length 1.5meter)
- 4 * NTC10K temperature sensor ($\phi 6 \times 50$ mm, cable length 3meter)
- 1 * Accessories bag
- 1 * power cable

2.3 Technical data

- Inputs: 2* PT1000 temperature sensors
6* NTC10K, B=3950 temperature sensors
1* Grundfos Direct Sensor (VFS type)
1* Rotary blade electronic flow meter(FRT)
- Output: 3* Electromagnetic relay, Max. current 1A
3* Semiconductor relay, Max. current 1A
1* low voltage relay (on/off signal), boiler on/off control
3* PWM variable frequency output (switchable 0-10V)
- **Functions: operating hour counter, tube collector function, thermostat function, pump speed control, heat quantity measurement, external heat exchange, swimming pool circuit system, adjustable system parameters and optional functions (menu-structure), balance and diagnostics**
- Power supply: 100...240V ~ (50...60Hz)
- Rated impulse voltage: 2.5KV
- Data interface : TF (Micro SD)
- Housing: Plastic ABS
- Mounting: Wall mounting
- Indication / Display: System-Monitoring-Display, for visualization of the systems, LED display, and background illumination
- Operation: 5 push buttons at the front cover
- Protection type: IP41
- Protection class: I
- Ambient temperature: 0 ... 40 °C
- Dimensions: 208*158*43mm



Note: TF (Micro SD) isn't included in the delivery list

3. Installation



Note: The unit should only be installed in the dry interior rooms. Please separate routing of sensor wires and mains wires. Make sure the controller as well as the system are not exposed to the strong electromagnetic fields.

3.1 Mounting controller

Follow the below steps to mount the controller on the wall.

- Unscrew the crosshead screw from the cover and remove it along with the cover from the housing.
- Mark the upper fastening point on the wall. Drill and fasten the enclosed wall plug and screw leaving the head protruding.
- Hang the housing from the upper fastening point and mark the lower fastening points (centers 180 mm).
- Drill and insert lower wall plugs.
- Fasten the housing to the wall with the lower fastening screw and tighten.
- Carry out the electrical wiring in accordance with the terminal allocation
- Put the cover on the housing. Attach with the fastening screw.



3.2 Wiring connection

According to the way of installation, wire can be connected from hole A on the bottom plate or from hole B, using a suitable tool (like knife) to cut the plastic of A.

Note: wires must be fastened by fixing clamps on position C.

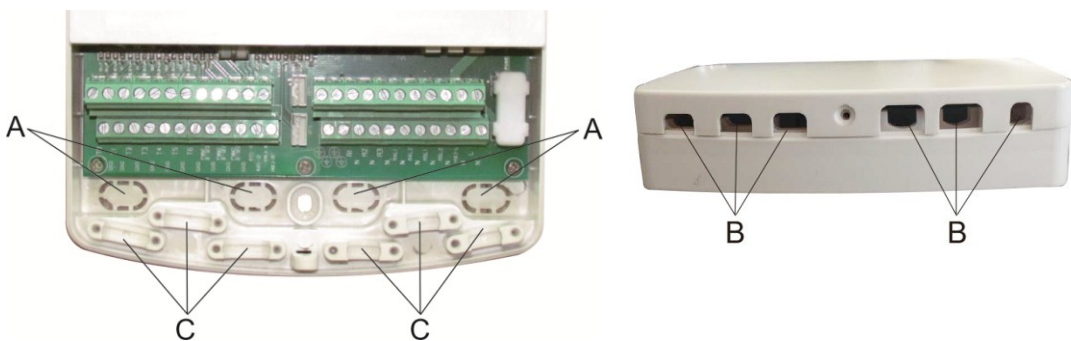

3.3 Terminal connection



Note: before opening the housing! Always disconnect the controller from power supply and obey the local electrical supply regulation.

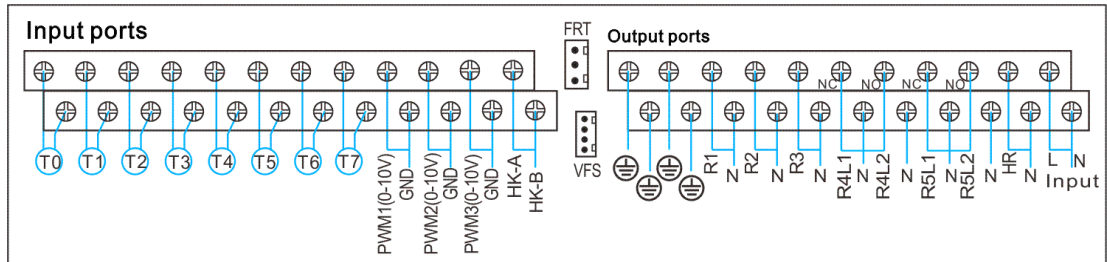

● Input terminals

T0~T1: PT1000 temperature sensor, for measuring the temperature of collector

T2~T7: NTC10K, B=3950 temperature sensor, for measuring temperature of tank and pipe

PWM1,PWM2, PWM3: Signal ports for high efficiency pump, detailed connection see below picture

HK-A, HK-B: Dry connection on/off signal ports, (HK and HR simultaneously open or close, for boiler heating control)

Communication port 485: ELA485, for remote control communication(function not available now)

FRT: For Rotary blade electronic flow meter

VFS: ForGrundfos flowmeter sensor

● Advice regarding the installation of temperature sensors:

- ① Only original factory equipped Pt1000 temperature sensors are approved for using with the collector, it is equipped with 1.5m silicon cable and suitable for all weather conditions, the cable is temperature resistant up to 280oC, connect the temperature sensors to the corresponding terminals with either polarity.
- ② Only original factory equipped NTC10K,B=3950 temperature sensors are approved for using with tank and pipe, it is equipped with 3m PVC cable, and the cable is temperature resistant up to 105°C, connect the temperature sensors to the corresponding terminals with either polarity.
- ③ All sensor cables carry low voltage, and to avoid inductive effects, must not be laid close to 230 Volt or 400 Volt cables (minimum separation of 100mm).
- ④ If external inductive effects are existed, e.g. from heavy current cables, overhead train

cables, transformer substations, radio and television devices, amateur radio stations, microwave devices etc., then the cables to the sensors must be adequately shielded.

- ⑤ Sensor cables may be extended to a maximum length of ca. 100 meter, when cable's length is up to 50m, and then 0.75mm² cable should be used. When cable's length is up to 100m, and then 1.5mm² cables should be used.

● **Output terminal**

Input Ports L, N: for power connection, L: live wire, N: zero wire,  protective ground wire

Output R1: Semiconductor relays (SCR), designed for pump speed control, Max. Current: 1A

Output R2: Semiconductor relays (SCR), designed for pump speed control, Max. Current: 1A

Output R3: Semiconductor relays (SCR), designed for pump speed control, Max. Current: 1A

Output R4: Electromagnetic relays, designed for on/off control of pump or 3-ways electromagnetic valve, Max. Current: 1A

Output R5: Electromagnetic relays, designed for on/off control of pump or 3-ways electromagnetic valve, Max. Current: 1A

Output HR: Electromagnetic relays, designed for on/off control of back-up heating device, Max. Current: 1A

- R4, R5 terminals for 3-ways valve / pump connection

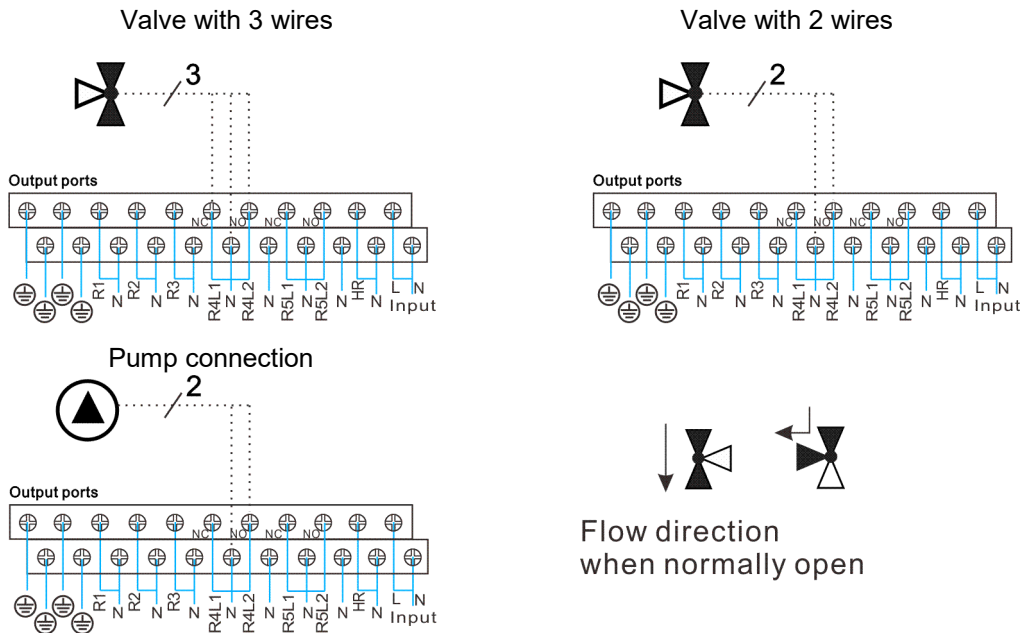

R4~R5: When it is for control 3 ways electromagnetic valve, (3 is normally close port, 2 is normally open port, 1 is common port)

When it is for control pump, (2 is normally open port, 1 is common port)

● Connection with high efficiency pump

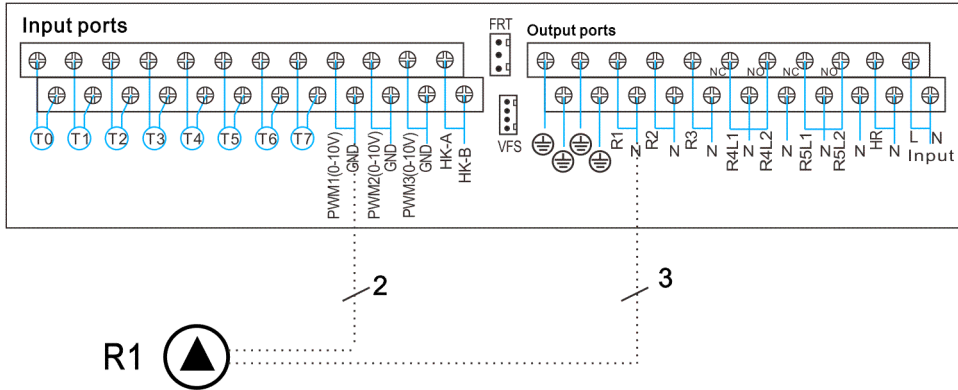

● Connecting the signal wire from the high-efficiency pump

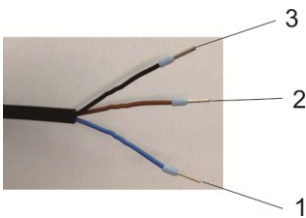

Signal	Overmoulded Pin	Cable color
PWM input (from controller)	1	Grey or blue
PWM common	2	brown
PWM output (from the pump)	3	black

Signal wire 1 from the high-efficiency pump is connected to GND port of controller

Signal wire 2 from the high-efficiency pump is connected to PWM1 port of controller

Signal wire 3 from the high-efficiency pump is signal wire FB1, it is not connected to FB1 port of controller

Some pumps connections are available as above, for example:

Wilo Yonos PARA ST15/7.0 PWM2 M

Grundfos UPM3 SOLAR 15-75 130 CZA

i Note:

- High-efficiency pump with 0-10V signal only has 2 signal wires, connected to the corresponding port GND, PWM1 (PWM2 or PWM3) of controller.
 - Blue wire not always represent for “GND” and brown wire not always represent for “PWM”.
- “PWM” from pump must be match for “PWM” from controller.
- “GND” from pump must be match for “GND” from controller.

3.4 TF (MicroSD) Card

- Controller is equipped with a slot for TF (Micro SD) card.
- With TF (MicroSD) card, following functions can be carried out
- Save the measurement value and parameters value onto the MicroSD TFcard. After transferring the data to a computer, the value can be opened and visualized, e. g. in a spreadsheet.
- Copy the updated firmware program from computer and install it on the controller via MicroSD card.



i **Note:**TF (MicroSD) card is not listed in the standard delivery package, self-purchase if need, more detailed about TF (MicroSD) see paragraph 7 (25)

4. System introduction

4.1 Overview of the available systems

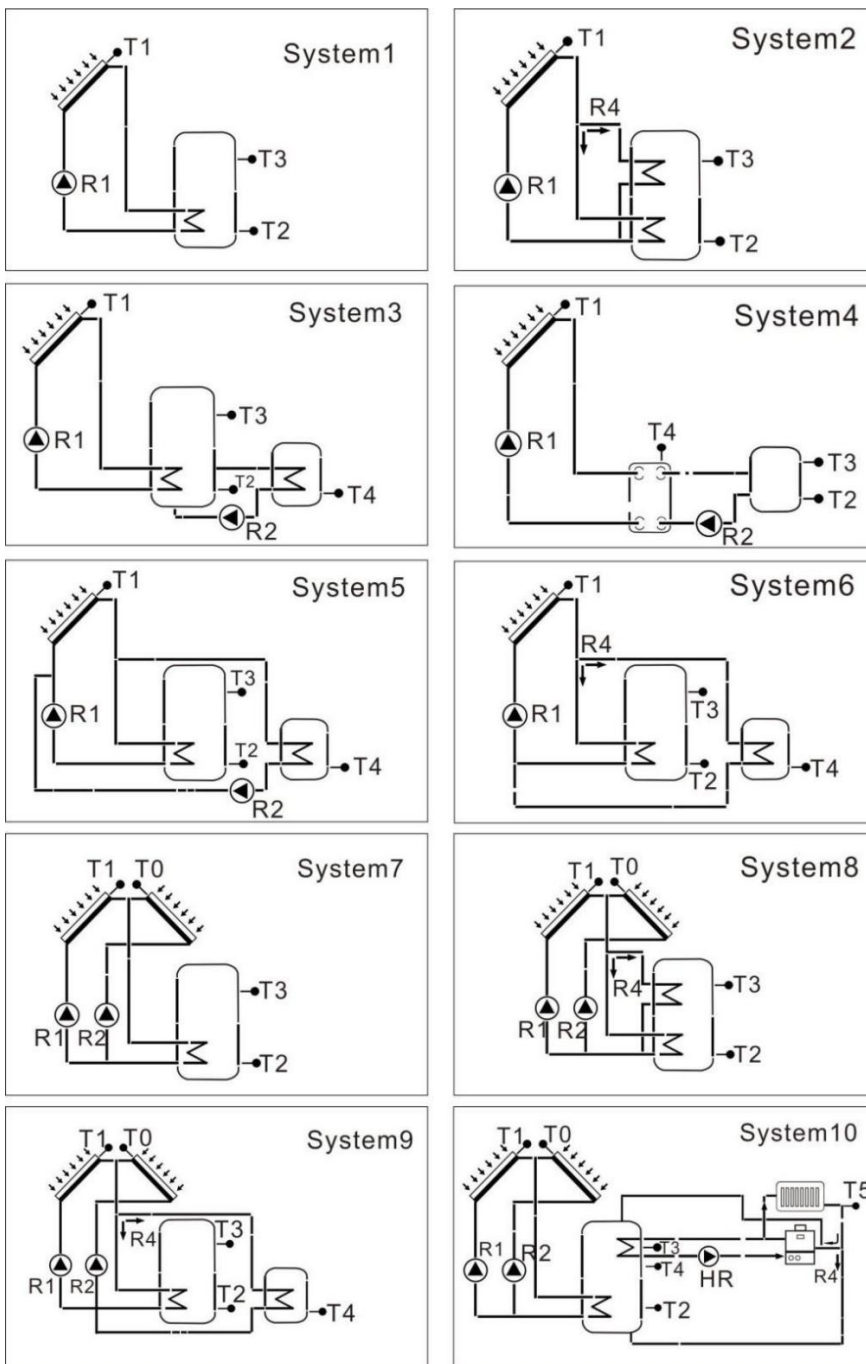

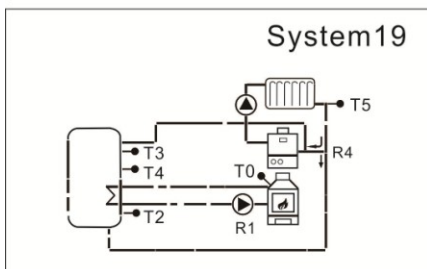
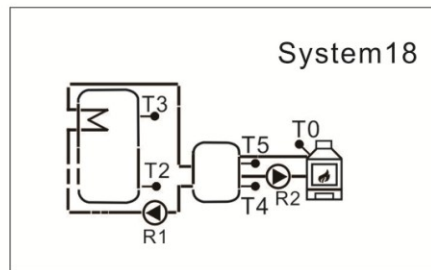
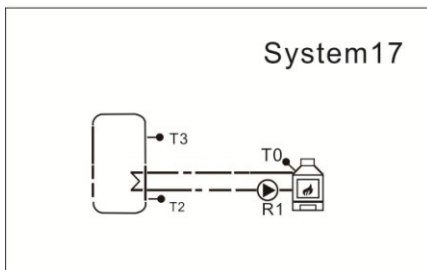
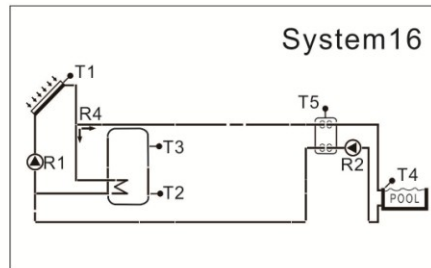
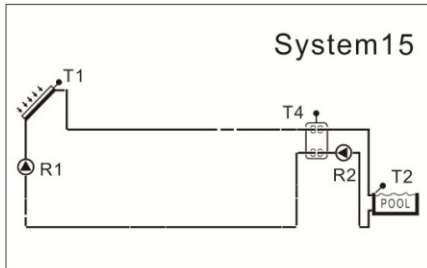
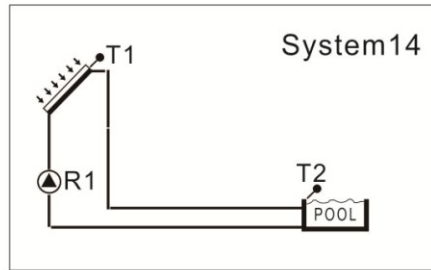
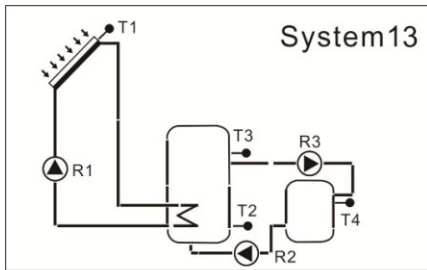
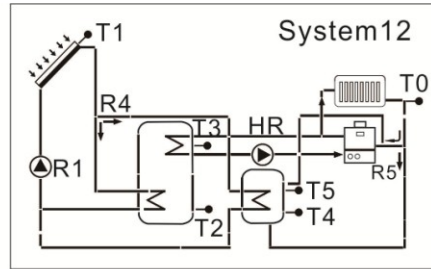
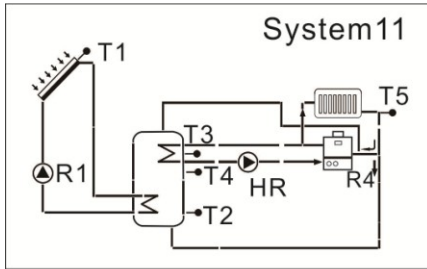

4.2 Description of 19 systems

System 1: Standard solar system with 1 tank, 1 collector field

Description:

The controller calculates the temperature difference between collector sensor T1 and tank sensor T2. If the difference is larger than or identical to the adjusted switch-on temperature difference, the solar circulation pump (R1) will be switched on and the tank will be loaded until the switch-off temperature difference or the maximum tank temperature is reached.

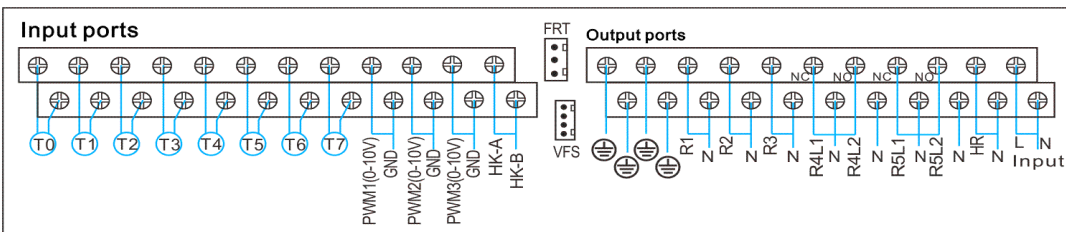
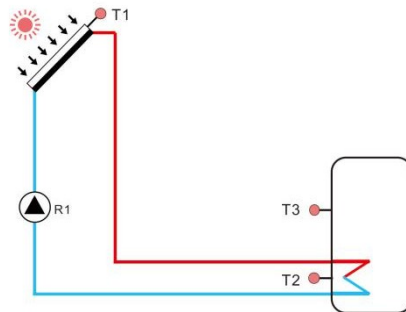
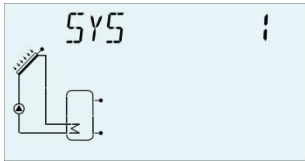

Sensor	Description	Relay	Description
T1	Temperature of collector	R1	Solar circulation pump
T2	Temperature of tank base	HR	Back-up heating
T3	Temperature of tank upper (optional one)		
T6	Optional free sensor, undefined(optional)		
T7	Temperature for thermal energy measurement (optional one)		

Auxiliary functions

Function code	Function description	Sensor	Relay output
CIRC	DHW circulation (controlled by temperature or flow impulse)	T5/flow switcher (connected on T5 port)	R2
SFB	Solid fuel boiler	T0	R3
OHDP	Thermal transfer -by external radiator		R4
TIMER	Timer function		R5

OPARR	Parallel relay		R2/R3/R4/R5 optional
AH	Thermostat function	T2/T3/T4 optional	R5

System 2: Solar system with 1 tank, 1 collector field, 3-ways valve for tank loading in layers

Description:

The controller calculates the temperature difference between collector sensor T1 and tank base and upper sensor T2, T3. If the difference is larger than or identical to the adjusted switch-on temperature difference, the solar circulation pump (R1) will be switched on, and simultaneously valve R4 turns to the corresponding tank zone and this zone will be loaded until the switch-off temperature difference or the maximum tank temperature is reached.

The priority logic effects prior loading of the upper zone of the tank. Please refer the Paragraph of "LLOGI Tank priority logic"

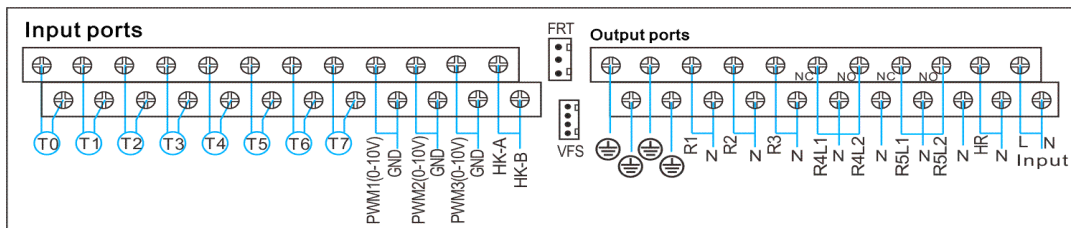
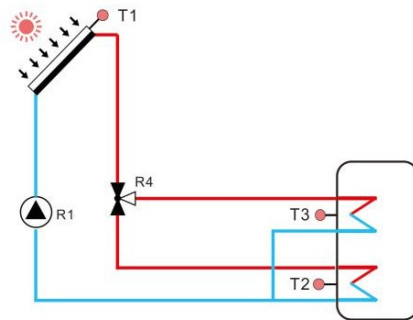
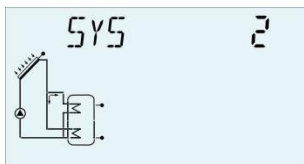

Sensor	Description	Relay	Description
T1	Temperature of collector	R1	Solar circulation pump
T2	Temperature of tank base	R4	1. Valve of solar circuit
T3	Temperature of tank upper (optional one)	HR	Back-up heating
T6	Return sensor(for thermal energy measurement)		
T7	Flow sensor(for thermal energy measurement)		

Auxiliary functions

Function code	Function description	Sensor	Relay output
CIRC	DHW circulation (controlled by temperature or flow impulse)	T5/flow switcher (connected on T5 port)	R2
SFB	Solid fuel boiler	T0	R3
OHDP	Thermal transfer -by external radiator		R5
TIMER	Timer function		R5
OPARR	Parallel relay		R2/R3/R5 optional
AH	Thermostat function	T2/T3/T4 optional	R5

System 3: Solar system with 1 collector filed, 2 tanks and thermal energy transferring between 2 tanks

Description:

The controller calculates the temperature difference between collector sensor T1 and tank 1 base sensor T2. If the differences is larger than or identical to the adjusted switch-on temperature difference, then the solar circulation pump (R1) will be switched on, tank will be loaded until the switch-off temperature difference or the maximum tank temperature is reached.

Thermal energy transferring means the other tank (2) is heated, another temperature difference controls the running of pump R2 (difference between T3 and T4 temperature.) Please refer the Paragraph 7.14 of "HEATX Energy exchange between tanks"

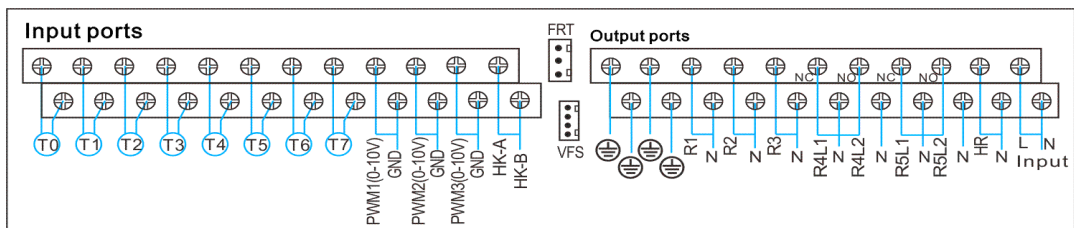
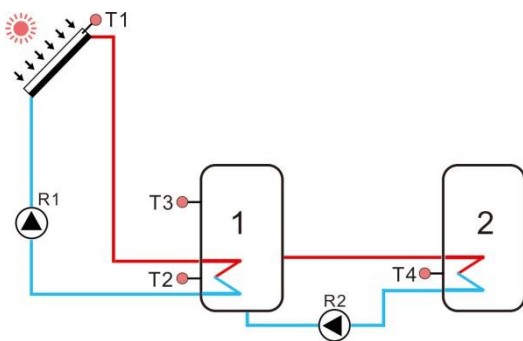
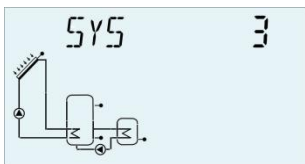

Sensor	Description	Relay	Description
T1	Temperature of collector	R1	Solar circulation pump
T2	Temperature of tank 1 base	R2	Pump for thermal transfer between tank
T3	Temperature of tank 1 upper (optional one)	HR	Back-up heating
T4	Temperature of tank 2		
T6	Return sensor(for thermal energy measurement)		
T7	Flow sensor(for thermal energy measurement)		

Auxiliary functions

Function code	Function description	Sensor	Relay output
CIRC	DHW circulation (controlled by temperature or flow impulse)	T5/flow switcher (connected on T5 port)	R4
SFB	Solid fuel boiler	T0	R3
OHDP	Thermal transfer -by external radiator		R5
TIMER	Timer function		R5
OPARR	Parallel relay		R3/R4/R5 optional
AH	Thermostat function	T2/T3/T4/T6 optional	R5

System 4: Standard solar system with heat exchanger control logic

Description:

The controller calculates the temperature difference between collector sensor T1 and tank base sensor T2. If the difference is larger than or identical to the adjusted switch-on temperature difference, then the corresponding solar circulation pump (R1) will be switched on, heat exchanger is heated until the switch-off temperature difference or the maximum exchanger temperature is reached.

By using another temperature difference between T4 and T2 controls pump R2 to load tank

Note: if sensor T4 is not installed, then when temperature difference between collector T1 and tank T2 is reached, pump R1 and R2 are triggered simultaneously, and pumps are ceased until the switch-off temperature reaches or the maximum exchanger temperature is reached.

Please refer the Paragraph 7.17 of "EXHX external heat exchanger"

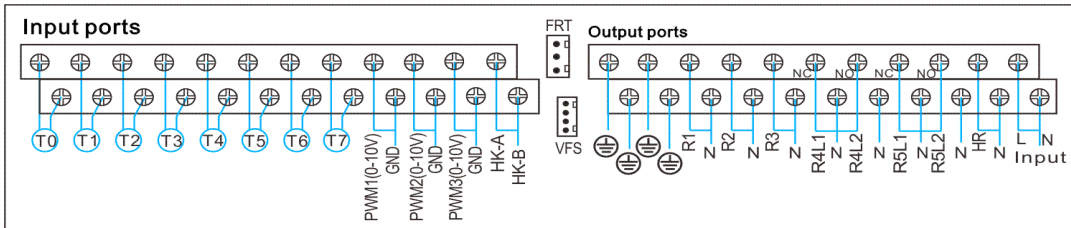
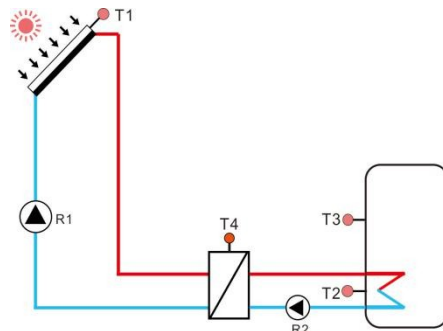
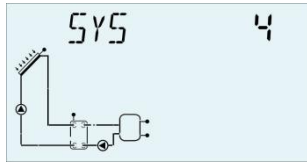

Sensor	Description	Relay	Description
T1	Temperature of collector	R1	Solar circulation pump1
T2	Temperature of tank base	R2	Pump for thermal transfer between heat exchanger and tank
T3	Temperature of tank upper (optional)	HR	Back-up heating
T4	Temperature of heat exchanger(optional)		
T6	Return sensor(for thermal energy measurement)		
T7	Flow sensor(for thermal energy measurement)		

Auxiliary functions

Function code	Function description	Sensor	Relay output
CIRC	DHW circulation (controlled by temperature or flow impulse)	T5/flow switcher (connected on T5 port)	R4
SFB	Solid fuel boiler	T0	R3
OHDP	Thermal transfer -by external radiator		R5
TIMER	Timer function		R5
OPARR	Parallel relay		R3/R4/R5 optional
AH	Thermostat function	T2/T3/T6 optional	R5

System 5: Solar system with 1 collector field, 2 tanks, pump -logic control

Description:

The controller calculates the temperature difference between collector sensor T1 and tank 1's base sensor T2 and T4. If any difference is larger than or identical to the adjusted switch-on temperature difference, then the corresponding solar circulation pump (R1 or R2) will be switched on, tank will be loaded until the switch-off temperature difference or the maximum tank temperature is reached.

The priority logic effects prior loading of the tank 1.
Please refer the Paragraph 7.12 of "LLOGI Tank priority logic"

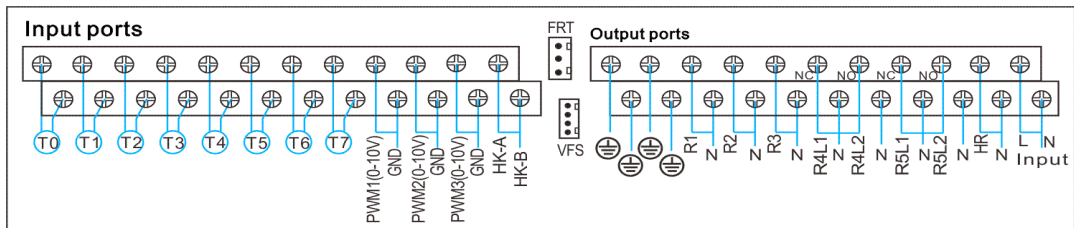
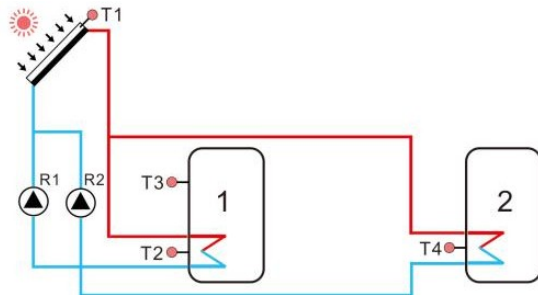
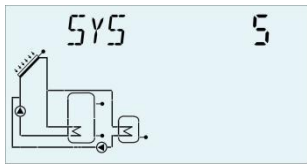

Sensor	Description	Relay	Description
T1	Temperature of collector	R1	Solar circulation pump 1
T2	Temperature of tank 1 base	R2	Solar circulation pump 2
T3	Temperature of tank 1 upper (optional)	HR	Back-up heating
T4	Temperature of tank 2 base		
T5	Temperature of tank 2 upper (optional)		
T6	Return sensor (for thermal energy measurement)		
T7	Flow sensor (for thermal energy measurement)		

Auxiliary functions

Function code	Function description	Sensor	Relay output
CIRC	DHW circulation (controlled by temperature or flow impulse)	T5/flow switcher (connected on T5 port)	R4

SFB	Solid fuel boiler	T0	R3
OHDP	Thermal transfer -by external radiator		R5
TIMER	Timer function		R5
OPARR	Parallel relay		R3/R4/R5 optional
AH	Thermostat function	T2/T3/T4/T6 optional	R5

System 6: Solar system with 1 collector field, 1 tank, valve logic control

Description:

The controller calculates the temperature difference between collector sensor T1 and tank 1's base sensor T2 and T4. If any difference is larger than or identical to the adjusted switch-on temperature difference, then the solar circulation pump (R1) will be switched on, and simultaneously valve R4 turns to the corresponding tank, and this tank will be loaded until the switch-off temperature difference or the maximum tank temperature is reached.

The priority logic effects prior loading of the tank 1.

Please refer the Paragraph 7.12of "LLOGI Tank priority logic"

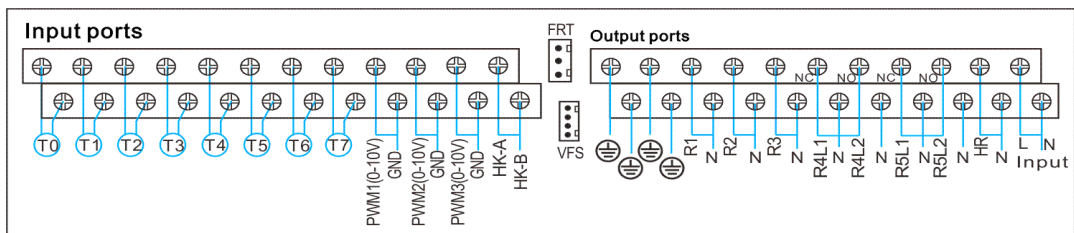
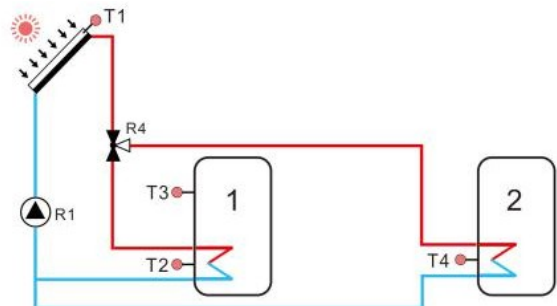
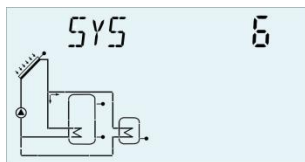

Sensor	Description	Relay	Description
T1	Temperature of collector	R1	Solar circulation pump 1
T2	Temperature of tank 1 base	R4	Valve of solar circuit
T3	Temperature of tank 1 upper (optional)	HR	Back-up heating
T4	Temperature of tank2base		
T5	Temperature of tank2upper (optional)		

T6	Return sensor(for thermal energy measurement)		
T7	Flow sensor(for thermal energy measurement)		

Auxiliary functions

Function code	Function description	Sensor	Relay output
CIRC	DHW circulation (controlled by temperature or flow impulse)	T5/flow switcher (connected on T5 port)	R2
SFB	Solid fuel boiler	T0	R3
OHDP	Thermal transfer -by external radiator		R5
TIMER	Timer function		R5
OPARR	Parallel relay		R2/R3/R5 optional
AH	Thermostat function	T2/T3/T4/T6 optional	R5

System 7: Solar system with east/west collector fields, 1 tank

Description:

The controller calculates the temperature difference between east/ west collector sensor T1 and T0 and tank base sensor T2. If any difference is larger than or identical to the adjusted switch-on temperature difference, then solar circulation pump (R1 or R2) will be switched on, and tank will be loaded until the switch-off temperature difference or the maximum tank temperature is reached.

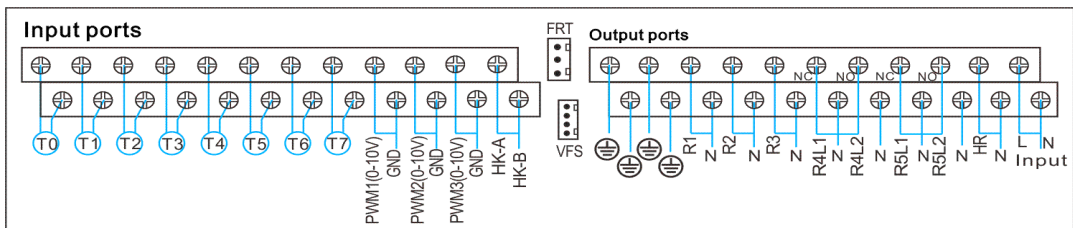
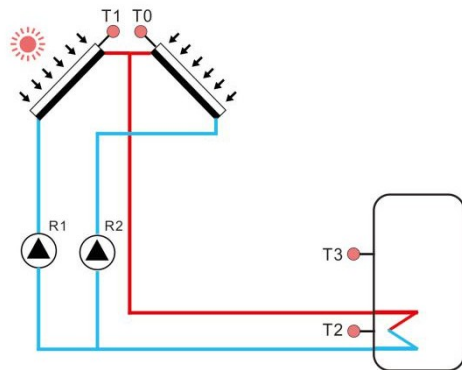
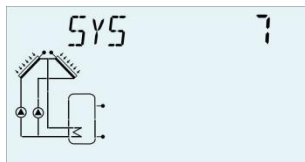

Sensor	Description	Relay	Description
T0	Temperature of collector 2	R1	Solar circulation pump 1
T1	Temperature of collector 1	R2	Solar circulation pump 2
T2	Temperature of tank base	HR	Back-up heating

T3	Temperature of tank upper (optional)		
T6	Return sensor(for thermal energy measurement)		
T7	Flow sensor(for thermal energy measurement)		

Auxiliary functions

Function code	Function description	Sensor	Relay output
CIRC	DHW circulation (controlled by temperature or flow impulse)	T5/flow switcher (connected on T5 port)	R4
SFB	Solid fuel boiler	T0	R3
OHDP	Thermal transfer -by external radiator		R5
TIMER	Timer function		R5
OPARR	Parallel relay		R3/R4/R5 optional
AH	Thermostat function	T2/T3/T6 optional	R5

System 8: Solar system with east/west collector field, valvelogiccontrol, loading in layers

Description:

The controller calculates the temperature difference between east/ west collector sensor T1 and T0 and tank base/ upper sensor T2 and T3. If any difference is larger than or identical to the adjusted switch-on temperature difference, then solar circulation pump (R1 or R2) will be switched on, and simultaneously valve R4 turns to the corresponding tank part, and this tank part will be loaded until the switch-off temperature difference or the maximum tank temperature is reached.

The priority logic effects prior loading of the upper part of tank. Please refer the Paragraph 7.12of "LLOGI Tank priority logic"

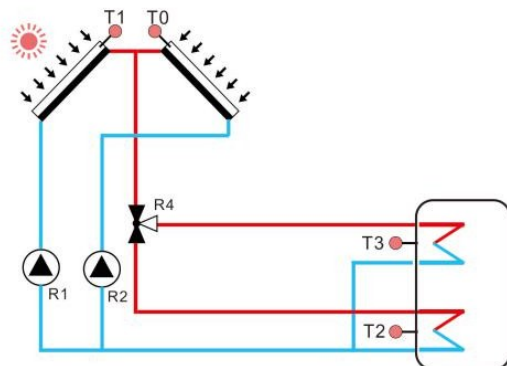
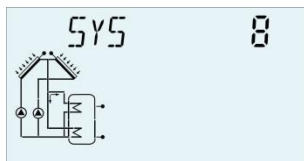

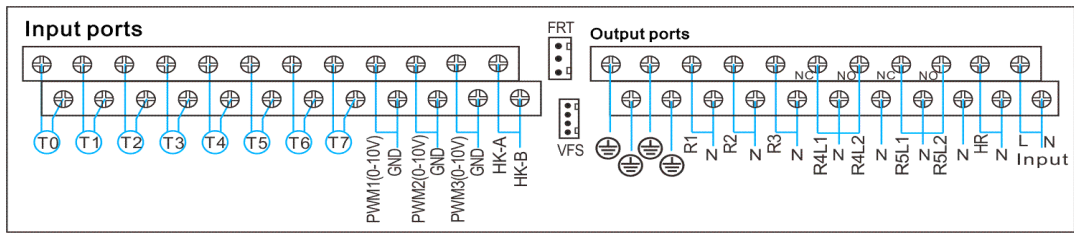

Sensor	Description	Relay	Description
T0	Temperature of collector 2	R1	Solar circulation pump 1
T1	Temperature of collector 1	R2	Solar circulation pump 2
T2	Temperature of tank base	R4	Valve of solar circuit
T3	Temperature of tank upper (optional)	HR	Back-up heating
T6	Return sensor(for thermal energy measurement)		
T7	Flow sensor(for thermal energy measurement)		

Auxiliary functions

Function code	Function description	Sensor	Relay output
CIRC	DHW circulation (controlled by temperature or flow impulse)	T4/flow switcher (connected on T4 port)	R5
SFB	Solid fuel boiler	T0	R3
OHDP	Thermal transfer -by external radiator		R5
TIMER	Timer function		R5
OPARR	Parallel relay		R3/R5 optional
AH	Thermostat function	T2/T3/T6 optional	R5

System 9: Solar system with east/west collector fields, 2 tanks, valve logic control

Description:

The controller calculates the temperature difference between east/ west collector sensor T1 and T0 and 2 tanks base sensor T2 and T4. If any difference is larger than or identical to the adjusted switch-on temperature difference, then solar circulation pump (R1 or R2) will be switched on, and simultaneously valve R4 turns to the corresponding tank, and this tank will be loaded until the switch-off temperature difference or the maximum tank temperature is reached.

The priority logic effects prior loading of the tank 1.

Please refer the Paragraph 7.12 of "LLOGI Tank priority logic"

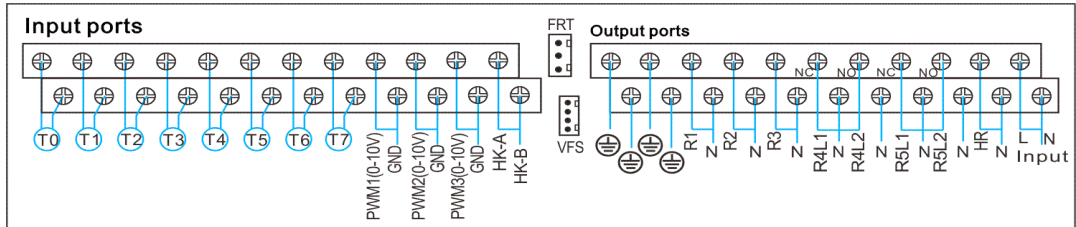
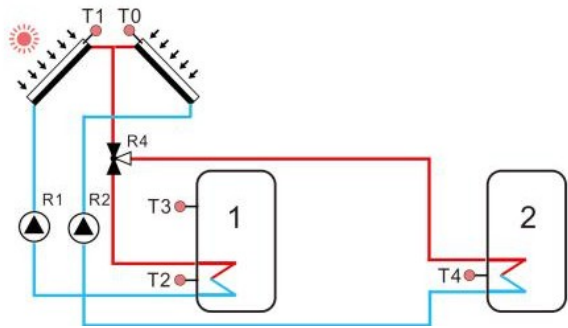
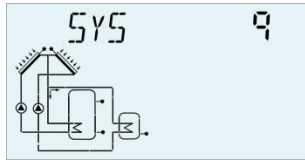

Sensor	Description	Relay	Description
T0	Temperature of collector 2	R1	Solar circulation pump 1
T1	Temperature of collector 1	R2	Solar circulation pump 2
T2	Temperature of tank 1 base	R4	Valve of solar circuit
T3	Temperature of tank 1 upper (optional)	HR	Back-up heating
T4	Temperature of tank 2 base		
T5	Temperature of tank 2 upper (optional)		
T6	Return sensor(for thermal energy measurement)		
T7	Flow sensor(for thermal energy measurement)		

Auxiliary functions

Function code	Function description	Sensor	Relay output
CIRC	DHW circulation (controlled by temperature or flow impulse)	T6/flow switcher (connected on T6 port)	R5
SFB	Solid fuel boiler	T0	R3
OHDP	Thermal transfer -by external radiator		R5
TIMER	Timer function		R5
OPARR	Parallel relay		R3/R5 optional
AH	Thermostat function	T2/T3/T4/T6 optional	R5

System 10: Solar system with east/west collector fields, 1 tank, loading the heating return

Description:

The controller calculates the temperature difference between east/ west collector sensor T1 and T0 and tank base sensor T2. If any difference is larger than or identical to the adjusted switch-on temperature difference, then solar circulation pump (R1 or R2) will be switched on, and this tank will be loaded until the switch-off temperature difference or the maximum tank temperature is reached.

By using another temperature difference between T4 and T5 controls valve R4 to load the heating return flow.

Please refer the Paragraph 7.15 of "RPH Heating return pipe preheat"

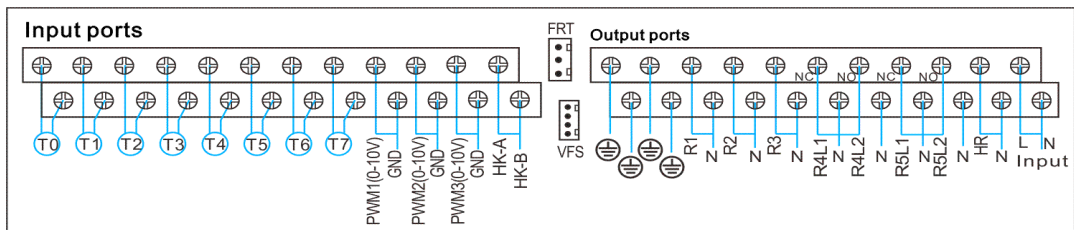
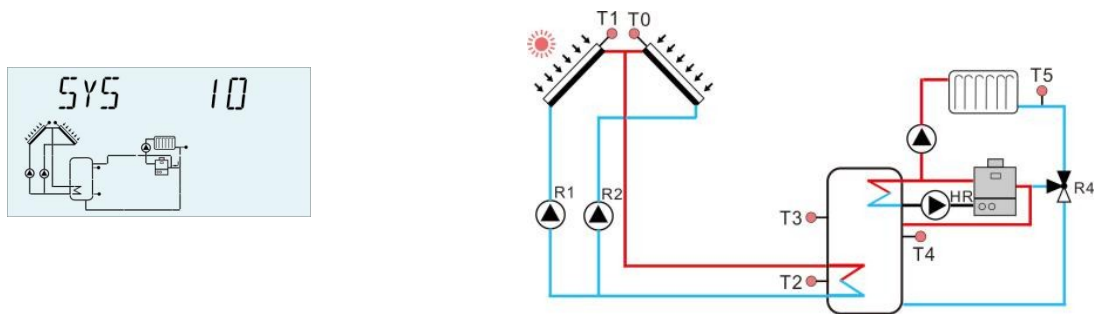

Sensor	Description	Relay	Description
T0	Temperature of collector 2	R1	Solar circulation pump 1
T1	Temperature of collector 1	R2	Solar circulation pump 2
T2	Temperature of tank base	R4	Valve of heating return
T3	Temperature of tank upper (optional)	HR	Back-up heating
T4	Temperature of tank middle for heating return(optional)		
T5	Temperature of heating return		
T6	Return sensor(for thermal energy measurement)		
T7	Flow sensor(for thermal energy measurement)		

Auxiliary functions

Function code	Function description	Sensor	Relay output

CIRC	DHW circulation (controlled by temperature or flow impulse)	T6/flow switcher (connected on T6 port)	R3
SFB	Solid fuel boiler	T6	R3
OHDP	Thermal transfer -by external radiator		R5
TIMER	Timer function		R5
OPARR	Parallel relay		R3/R5 optional
AH	Thermostat function	T2/T3/T4/T6 optional	R5

System 11: Solar system with 1 collector field, 1 tank, loading the heating return

Description:

The controller calculates the temperature difference between collector sensor T1 and tank sensor T2. If the difference is larger than or identical to the adjusted switch-on temperature difference, then solar circulation pump (R1) will be switched on, and this tank will be loaded until the switch-off temperature difference or the maximum tank temperature is reached.

By using another temperature difference between T4 and T5 controls valve R4 to load the heating return flow.

Please refer the Paragraph 7.15 of "RPH Heating return pipe preheat"

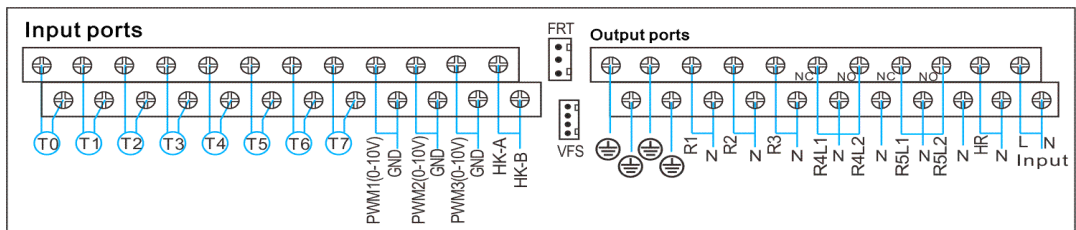
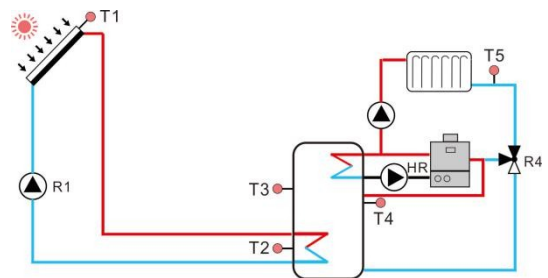
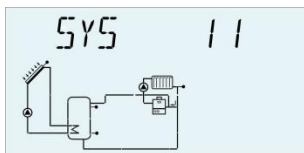

Sensor	Description	Relay	Description
T1	Temperature of collector	R1	Solar circulation pump 1
T2	Temperature of tank base	R4	Valve of heating return
T3	Temperature of tank upper (optional)	HR	Back-up heating
T4	Temperature of tank middle for		

	heating return(optional)		
T5	Temperature of heating return		
T6	Return sensor(for thermal energy measurement)		
T7	Flow sensor(for thermal energy measurement)		

Auxiliary functions

Function code	Function description	Sensor	Relay output
CIRC	DHW circulation (controlled by temperature or flow impulse)	T6/flow switcher (connected on T6 port)	R2
SFB	Solid fuel boiler	T0	R3
OHDP	Thermal transfer -by external radiator		R5
TIMER	Timer function		R5
OPARR	Parallel relay		R2/R3/R5 optional
AH	Thermostat function	T2/T3/T4/T6 optional	R5

System 12: Solar system with 1 collector field, 2 tanks, valvelogic, heating return loading

Description:

The controller calculates the temperature difference between collector sensor T1 and 2 tank's sensor T2 and T4. If the difference is larger than or identical to the adjusted switch-on temperature difference, then solar circulation pump (R1) will be switched on, and simultaneously valve R4 turns to the corresponding tank, and this tank will be loaded until the switch-off temperature difference or the maximum tank temperature is reached.

The priority logic effects prior loading of the tank 1.
Please refer the Paragraph 7.12 of "LLOGI Tank priority logic"

By using another temperature difference between T5 and T6 controls valve R5 to load the heating return flow.
Please refer the Paragraph 7.15 of "RPH Heating return pipe preheat"

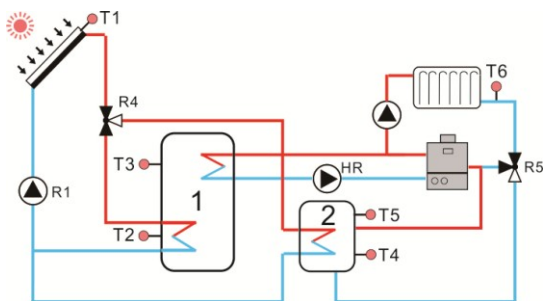
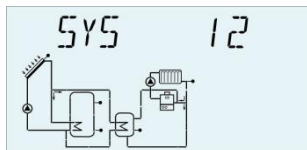

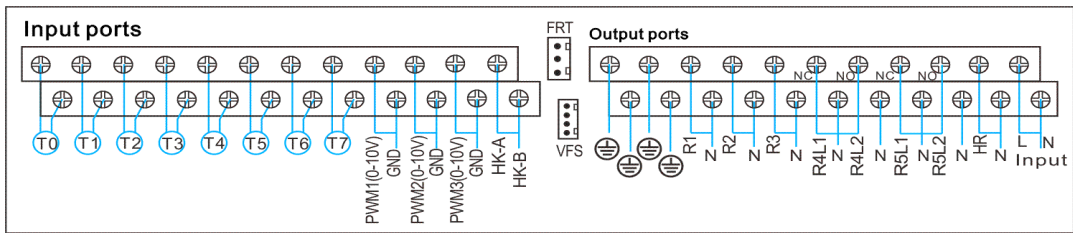

Sensor	Description	Relay	Description
T0	Temperature of heating return	R1	Solar circulation pump 1
T1	Temperature of collector	R4	Valve of solar circuit
T2	Temperature of tank 1 base	R5	Valve of heating return
T3	Temperature of tank 1 upper (optional)	HR	Back-up heating
T4	Temperature of tank 2 base		
T5	Temperature of tank 2 upper (optional)		
T6	Return sensor(for thermal energy measurement)		
T7	Flow sensor(for thermal energy measurement)		

Auxiliary functions

Function code	Function description	Sensor	Relay output
CIRC	DHW circulation (controlled by temperature or flow impulse)	T6/flow switcher (connected on T6 port)	R3
SFB	Solid fuel boiler	T6	R3
OHDP	Thermal transfer -by external radiator		R2
TIMER	Timer function		R2
OPARR	Parallel relay		R2/R3/ optional
AH	Thermostat function	T2/T3/T4/T5optional	R2

System 13: Solar system with 1 collector field, 2 tanks, thermal energy transferring

Description:

The controller calculates the temperature difference between collector sensor T1 and tank 1's sensor T2. If the difference is larger than or identical to the adjusted switch-on temperature difference, then solar circulation pump (R1) will be switched on, and this tank will be loaded until the switch-off temperature difference or the maximum tank temperature is reached.

Thermal energy transferring between 2 tanks:

When tank 1's temperature reaches the switch-on temperature (L1H2O), and temperature of tank 1 is larger than tank 2 (T3>T4), pump R2 is triggered; when tank 1's temperature drops below its switch off temperature (L1H2F) or temperature of tank 2 rises to the same

temperature of tank 1, or temperature of tank 2 reaches its maximum value S2MAX, then pump R2 is stopped

When tank 2's temperature reaches the switch-on temperature (L2H1O), and temperature of tank 2 is larger than tank 1 ($T4 > T3$), pump R3 is triggered; when tank 2's temperature drops below its switch off temperature (L2H1F) or temperature of tank 1 rises to the same temperature of tank 2, or temperature of tank 1 reaches its maximum value SMAX, then pump R3 is stopped.

Please refer the Paragraph 7.16 of "DLHTX Thermal energy transferring between tanks"

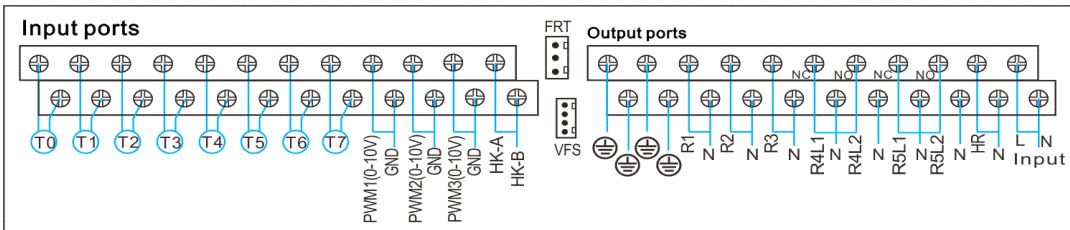
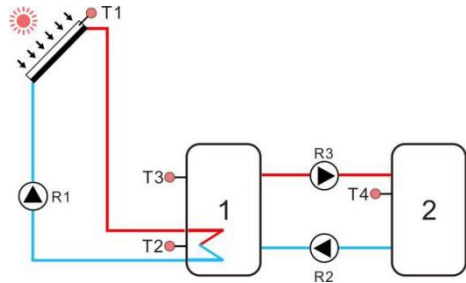
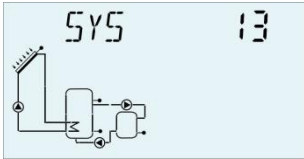

Sensor	Description	Relay	Description
T1	Temperature of collector	R1	Solar circulation pump 1
T2	Temperature of tank1base	R2	Heating transfer 1 to 2 pump 2
T3	Temperature of tank1 upper (optional)	R3	Heating transfer 2 to 1 pump 3
T4	Temperature of tank2	HR	Back-up heating
T6	Return sensor(for thermal energy measurement)		
T7	Flow sensor(for thermal energy measurement)		

Auxiliary functions

Function code	Function description	Sensor	Relay output
CIRC	DHW circulation (controlled by temperature or flow impulse)	T5/flow switcher (connected on T5 port)	R4
SFB	Solid fuel boiler	T0	R5
OHDP	Thermal transfer -by external		R5

	radiator		
TIMER	Timer function		R5
OPARR	Parallel relay		R4/R5 optional
AH	Thermostat function	T2/T3/T4 optional	R5

System 14: Solar system with 1 collector field, swimming pool heating

Description:

The controller calculates the temperature difference between collector sensor T1 and swimming pool sensor T2. If the difference is larger than or identical to the adjusted switch-on temperature difference, then solar circulation pump (R1) will be switched on, and swimming pool will be loaded until the switch-off temperature difference or the maximum swimming pool temperature is reached.

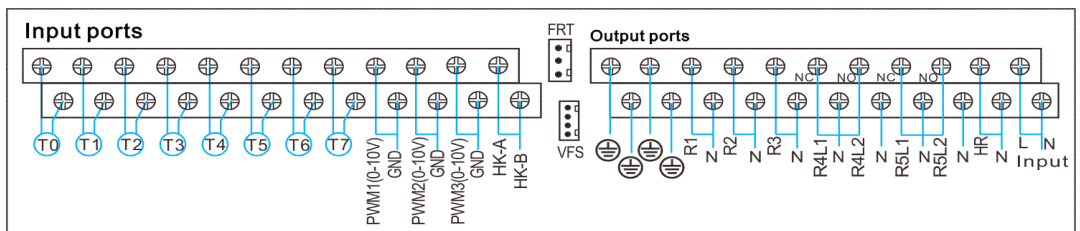
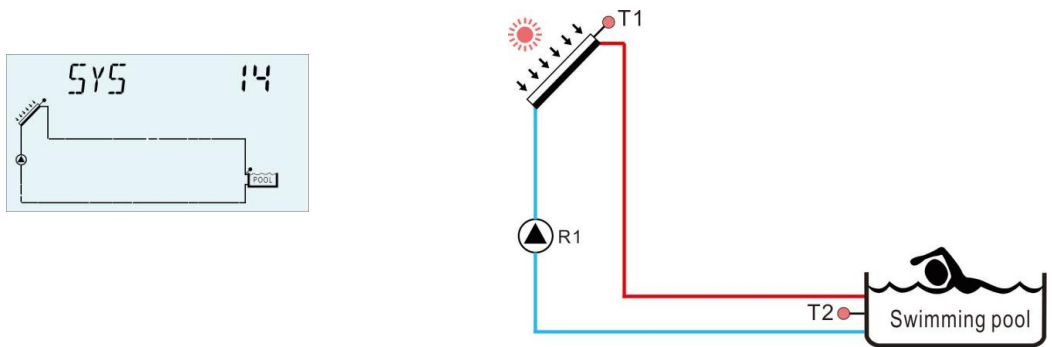

Sensor	Description	Relay	Description
		R1	Solar circulation pump
T1	Temperature of collector	HR	Back-up heating
T2	Temperature of swimming pool		
T6	Return sensor(for thermal energy measurement)		
T7	Flow sensor(for thermal energy measurement)		

Auxiliary functions

Function code	Function description	Sensor	Relay output
OHDP	Thermal transfer -by external radiator		R4

TIMER	Timer function		R5
OPARR	Parallel relay		R2/R3/R4/R5 optional
AH	Thermostat function	T2/T3/T4/T5 optional	R5

System 15: Solar system with 1 collector field, heat exchanger and swimming pool heating

Description:

The controller calculates the temperature difference between collector sensor T1 and heat exchanger sensor T2. If the difference is larger than or identical to the adjusted switch-on temperature difference, then solar circulation pump (R1) will be switched on. When temperature difference between collector sensor T1 and heat exchanger sensor T2 drops to the switch-off temperature difference or the maximum swimming pool temperature is reached, then solar pump R1 is ceased.

By using another temperature difference between T4 and T2, R2 can be triggered to heat swimming pool.

The controller calculates the temperature difference between heat exchanger sensor T4 and swimming pool T2. If the difference is larger than or identical to the adjusted switch-on temperature difference, then solar circulation pump (R2) will be switched on. When temperature difference between heat exchanger sensor T4 and swimming pool T2 drops to the switch-off temperature difference or the maximum swimming pool (T2) temperature is reached, then solar pump R2 is ceased.

Note: when T4 is not installed, then temperature difference between collector T1 and swimming pool T2 is larger than or identical to the adjusted switch-on temperature difference, then solar circulation pump (R1 and R2) will be switched on simultaneously. And when temperature difference between collector sensor T1 and swimming pool T2 drops to the switch-off temperature difference or the maximum swimming pool (T2) temperature is reached, then solar pump R1 and R2 are ceased simultaneously.

Please refer the Paragraph 7.17 of "EXHX external heat exchanger function"

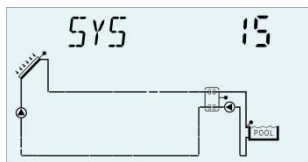
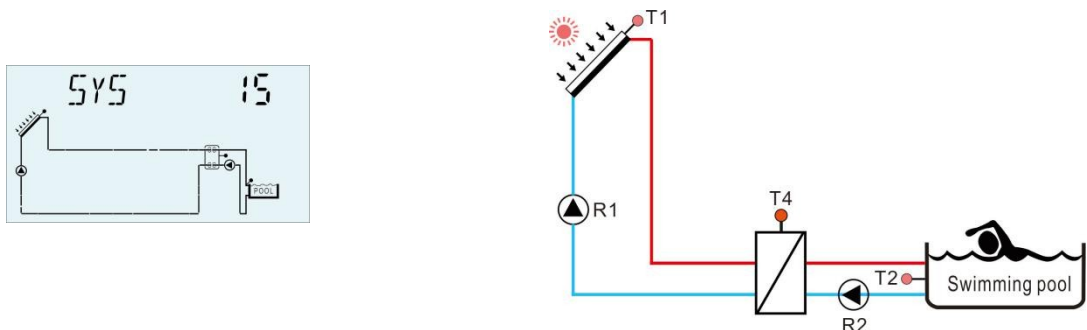

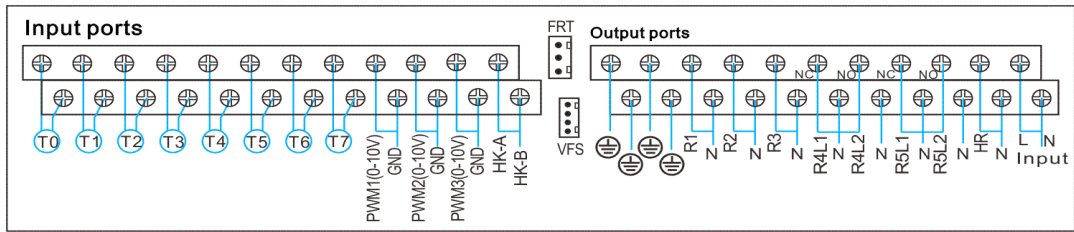

Sensor	Description	Relay	Description
T1	Temperature of collector	R1	Solar circulation pump 1
T2	Temperature of swimming pool(optional)	R2	Circuit pump between HE and swimming pool
T4	Temperature of heat exchanger(optional)	HR	Back-up heating
T6	Return sensor(for thermal energy measurement)		
T7	Flow sensor(for thermal energy measurement)		

Auxiliary functions

Function code	Function description	Sensor	Relay output
OHDP	Thermal transfer -by external radiator		R5
TIMER	Timer function		R4
OPARR	Parallel relay		R3/R4/R5 optional
AH	Thermostat function	T2/T3/T5optional	R4

System 16: Solar system with 1 collector field,1 tank, swimming pool, valve and heat exchanger control

Description:

The controller calculates the temperature difference between collector sensor T1 and tank or heat exchanger sensor (T2, T5). If the difference is larger than or identical to the adjusted switch-on temperature difference, then solar circulation pump (R1) will be switched on. And according to priority logic, valve R4 turns to the tank or heat exchanger, tank and heat exchanger is heated one by one. When temperature difference between collector sensor T1 and tank or heat exchanger sensor (T2, T5) drops to the switch-off temperature difference or the maximum temperature of tank (T2) or swimming pool (T5) is reached, then solar pump R1 is ceased.

The priority logic effects prior loading of the tank. Please refer the paragraph 7.12 of "LLOGI Tank priority logic"

By using another temperature difference between T5 and T4, R2 can be triggered to heat swimming pool.

Note: when T5 is not installed, then temperature difference between collector T1 and swimming pool T4 is larger than or identical to the adjusted switch-on temperature difference, then solar circulation pump (R1 and R2) and valve R4 all will be switched on simultaneously. And when temperature difference between collector sensor T1 and swimming pool T4 drops to the switch-off temperature difference or the maximum swimming pool (T4) temperature is reached, then solar pump R1, R2 and valve R4 are ceased simultaneously.

Please refer the paragraph 7.17 of "EXHX external heatex changer function"

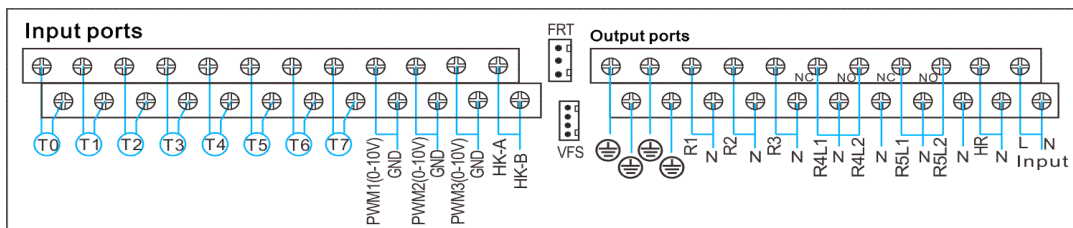
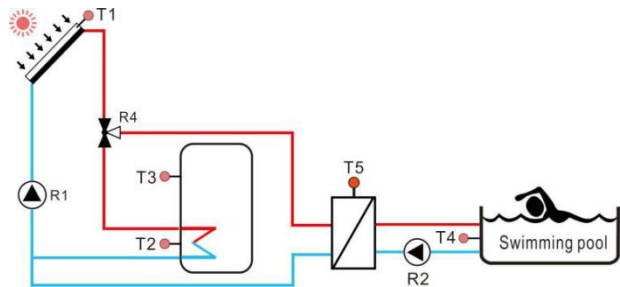
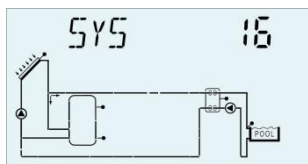

Sensor	Description	Relay	Description
T1	Temperature of collector	R1	Solar circulation pump 1
T2	Temperature of tank base	R2	Circuit pump for external heat exchanger
T3	Temperature of tank upper(optional)	R4	Solar circuit valve
T4	Temperature of swimming pool	HR	Back-up heating
T5	Temperature of heat exchanger(optional)		
T6	Return sensor(for thermal energy measurement)		
T7	Flow sensor(for thermal energy measurement)		

Auxiliary functions

Function code	Function description	Sensor	Relay output

CIRC	DHW circulation (controlled by temperature or flow impulse)	T6/flow switcher (connected on T6 port)	R5
SFB	Solid fuel boiler	T0	R3
OHDP	Thermal transfer -by external radiator		R5
TIMER	Timer function		R5
OPARR	Parallel relay		R3/R5 optional
AH	Thermostat function	T2/T3/T4/T6optional	R5

System 17: System with 1 tank and solid fuel boiler

Description:

solid fuel boiler function is designed to transfer the thermal energy from solid fuel boiler to tank.

The controller calculates the temperature difference between solid fuel boiler sensor T0 and tank sensor (T2 or T3). If the difference is larger than or identical to the adjusted switch-on temperature difference, and meet below two conditions, circulation pump (R1) will be switched on. And when temperature difference between sensor T0 and tank T2 or T3 drops to the switch-off temperature difference, pump R1 is ceased.

- 1) Temperature of solid fuel boiler is higher than the preset minimum temperature of boiler.
- 2) Temperature of tank sensor is lower than the preset maximum temperature of tank.

Please refer the paragraph 7.18of "Solid fuel boiler function"

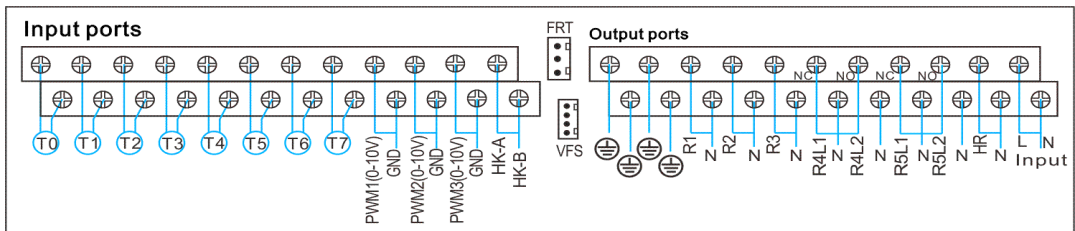
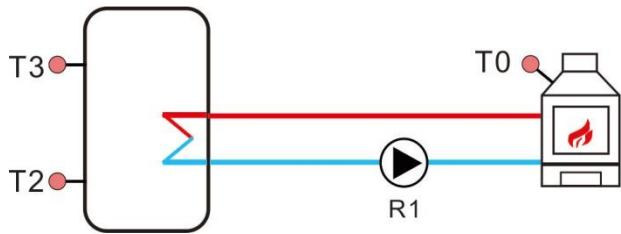
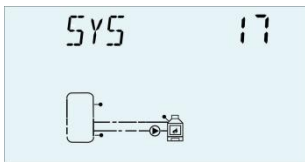

Sensor	Description	Relay	Description
T2	Temperature of tank base	HR	Back-up heating

T3	Temperature of tank upper(Optional)		
----	-------------------------------------	--	--

Auxiliary functions

Function code	Function description	Sensor	Relay output
CIRC	DHW circulation (controlled by temperature or flow impulse)	T6/flow switcher (connected on T6 port)	R3
SFB	Solid fuel boiler	T0	R1
TIMER	Timer function		R4
AH	Thermostat function	T2/T3/T4optional	R5

System 18: System with 2 tanks, thermal energy transferring and solid fuel boiler

Description:

Thermal energy transferring function is designed to heat one tank by another tank which has heat source tank/ T4 tank be heated)

Please refer the paragraph7.14 of "HEATX Energy exchange between tanks"

solid fuel boiler function is designed to transfer the thermal energy from solid fuel boiler to tank.

Please refer the paragraph7.18 of " SFB solid fuel boiler function"

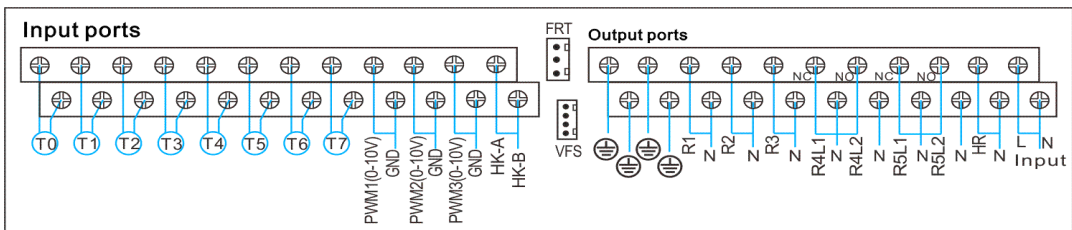
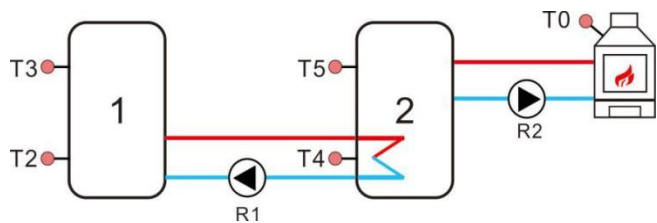
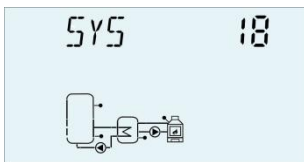

Sensor	Description	Relay	Description
T2	Temperature of tank1 base	R1	Pump for tank heat transferring
T3	Temperature of tank1 upper(Optional)	HR	Back-up heating
T4	Temperature of tank2 base		

T5	Temperature of tank2 upper(Optional)		
----	--------------------------------------	--	--

Auxiliary functions

Function code	Function description	Sensor	Relay output
CIRC	DHW circulation (controlled by temperature or flow impulse)	T6/flow switcher (connected on T6 port)	R3
SFB	Solid fuel boiler	T0	R2
TIMER	Timer function		R4
AH	Thermostat function	T2/T3/T4/T5 optional	R5

System 19: System with 1 tank, heating return and solid fuel boiler

Description:

Temperature between heat source T4 and heating return T5 is designed to trigger valve R4.. Please refer the Paragraph 7.15 of "RPH Heating return pipe preheat"

solid fuel boiler function is designed to transfer the thermal energy from solid fuel boiler to tank.

Please refer the paragraph 7.18 of " SFB solid fuel boiler function"

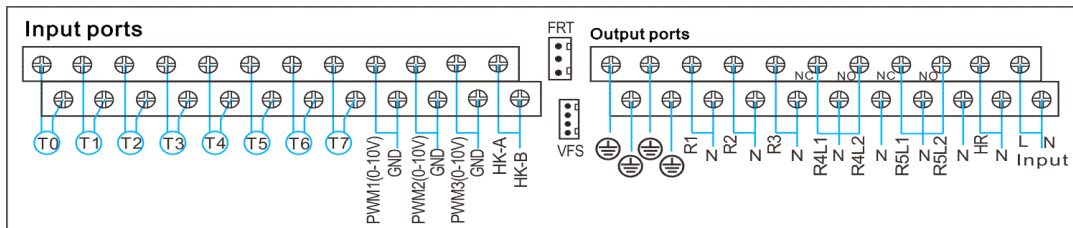
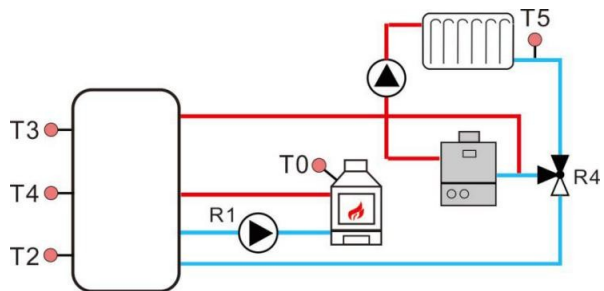
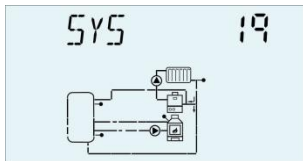

Sensor	Description	Relay	Description
T2	Temperature of tank base	R4	Valve of heating return
T3	Temperature of tank upper (Optional)	HR	Back-up heating
T4	Temperature of tank middle for heating return (Optional)		

T5	Temperature of heating return		
----	-------------------------------	--	--

Auxiliary functions

Function code	Function description	Sensor	Relay output
CIRC	DHW circulation (controlled by temperature or flow impulse)	T6/flow switcher (connected on T6 port)	R3
SFB	Solid fuel boiler	T0	R1
TIMER	Timer function		R2
AH	Thermostat function	T2/T3/T4optional	R5

4.3 Commissioning



Before connecting the controller to the mains, ensure system is filled and ready for operation, please connecting all sensors to the input terminals, pumps or valves to the output terminals and fill the system.

After power is switch on, the controller runs an initialization phase for 5 seconds, then controller runs a commissioning menu, it leads the user through the most important adjustment channels needed for operating the system.

5. Functions and options

5.1 Overview of menu structure

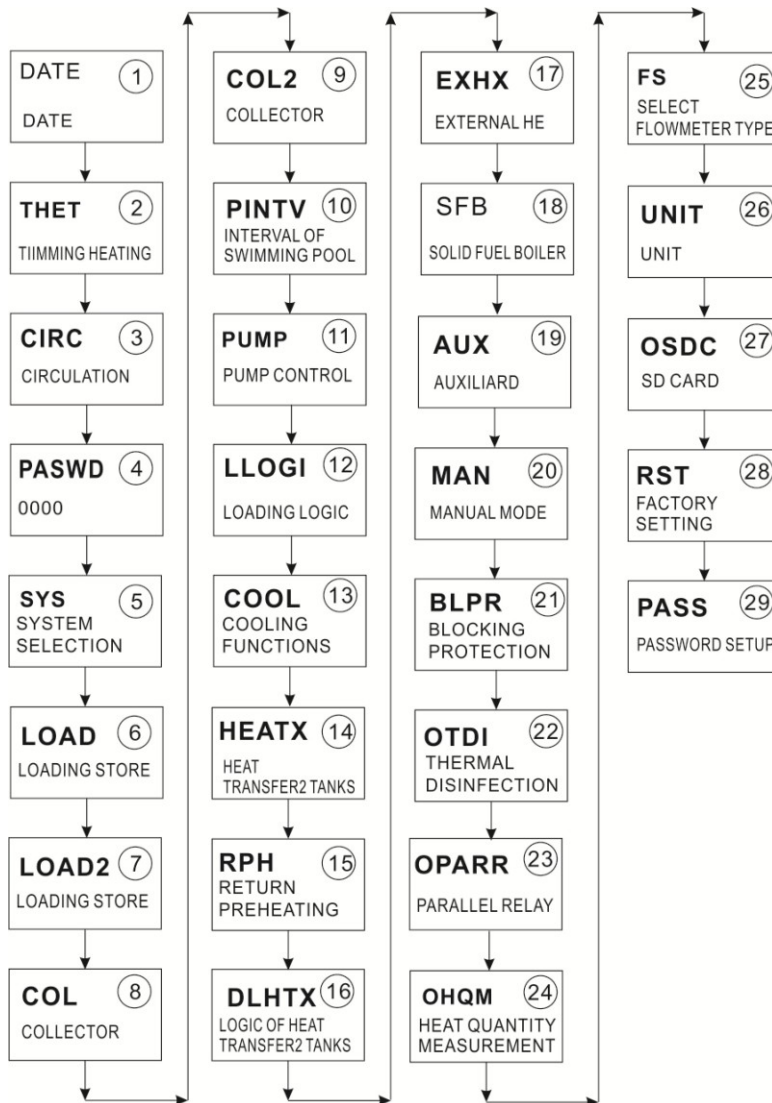

5.2 Menu operation description

- **Access main menu**
 - ▶ press “SET” button to access main menu
 - ▶ Press “↑”, “↓” to select menu
 - ▶ Press “SET” button to enter the submenu

- **Access submenu**

- ▶ Press “SET” button to access submenu
- ▶ Press “↑”, “↓” button to select submenu to be adjusted
- ▶ Press “SET” button to enter this submenu
- ▶ Press “SET” button, “OFF” or “ON” blinks on the screen
- ▶ Press “↑”, “↓” button, select “ON” to trigger the menu, or select “OFF” to close the menu
- ▶ Press “SET” or “ESC” button, to confirm the selection
- ▶ Press “↑” button to access the next submenu
- ▶ Press “SET” button to access value adjust
- ▶ Press “↑”, “↓” button to adjust value
- ▶ Press “SET” or “ESC” button, to confirm the value
- ▶ Press “ESC” to exit the menu.



Note: Enter the menu adjustment interface, if you don't press any button within 5 minutes, screen will exit the adjustment and turn to the main interface.

5.3 Check value

At the normal operation mode, press “↑”, “↓” button, you can view the temperature of collector and tank, temperature of Grundfos sensor(TVFS), pump speed(n%), accumulated pump running time(hR), current thermal energy(DKWH) accumulated thermal energy(KWh /MWh), flow rate(L/M), controller running time (DAYS), software version (SW), Year/Month/Day, Time Under standby status, press “SET” button for 3 seconds, then press “↑”, “↓” button to check the type of pump and unblock function.



Note: Enter the value checking interface, if you don't press any button within 5 minutes, screen will exit the adjustment and turn to the main interface.

5.4 Quick trigger function of back-up heating and circuit pump

1. Under standby status, press “ESC” button for 3 seconds, it is possible to manually trigger on the circuit pump, after fifteen minutes or repress the “ESC” button for 3 seconds, then the circuit pump is stopped.

2. Under standby status, press “↑” for 3 seconds, manual back-up heating is triggered. Press “↑”, “↓” button to adjust the temperature set point, press “ESC” button to confirm the parameter and trigger back-up heating, when the temperature reaches, manual heating is stopped. During the period of manual heating process, repress “↑” for 3 seconds, to switch-off manual heating immediately. (This function is only available when the back-up heating THET function is

running.

6. Menu function and parameter set (for user)

(1) Date(Time/ Date set)

Main menu	Submenu 1	Submenu 2	Default set	Adjust range	Adjust step	Description
DATE						Time/date setup
	TIME					Hour/minute
	ADST		OFF	ON/OFF		Summer time on/off
	YYYY					Year
	MM/DD					Month/day

- ADST: Switch on/off the summer time function

When you deactivate the “summer time function”, controller can still run, “ADST” is only referring directives Europe 200/84/EG, only suitable for Europe union country.



Note: In the case power to controller is switched-off, date and time will be remembered in controller for 36 hours.

Function setup:

- ▶ Press “SET” button, select DATE menu
- ▶ Press “SET” button, “TIME00:00” displays on the screen
- ▶ Press “SET” button, time zone hour “00” blinks
- ▶ Press “↑”, “↓” button to adjust hour time
- ▶ Press “SET” button, time zone minute “00” blinks
- ▶ Press “↑”, “↓” button to adjust minute time
- ▶ Press “SET” or “ESC” button, to confirm the setting



- ▶ Press “↑” button, “ADST OFF” displays on the screen (summer time)
- ▶ Press “SET” button, “OFF” blinks
- ▶ Press “↑”, “↓” button to activate summer timer function
- ▶ Press “SET” or “ESC” button, to confirm the setting



- ▶ Press “↑” button, “YYYY2015” displays on the screen, adjust year.
- ▶ Press “SET” button, “2015” blinks
- ▶ Press “↑”, “↓” button to adjust year
- ▶ Press “SET” or “ESC” button, to confirm the setting

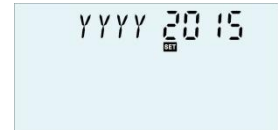

- ▶ Press “↑” button, “MM01” displays on the screen, adjust month.
- ▶ Press “SET” button, “01” blinks
- ▶ Press “↑”, “↓” button to adjust month
- ▶ Press “SET” or “ESC” button, to confirm the setting



- ▶ Press “↑” button, “DD01” displays on the screen, adjust day.
- ▶ Press “SET” button, “01” blinks
- ▶ Press “↑”, “↓” button to adjust day
- ▶ Press “SET” or “ESC” button, to confirm the setting



(2) THET Timed back-up heating

Timed heating

An electrical back-up heater is possible to be installed in a solar system, controller can provide automatic thermostat control function, when tank temperature T2 drops below the preset switch – on temperature of this function, electrical heater(HR) will be triggered and when tank temperature T2 rises to the preset switch-off temperature, electrical heater(HR) is stopped.

Two kinds of heating device(heating mode) are available:

- Electrical heater as back-up heat resource (ELET)
- Boiler as back-up heat resource (BOIL)

i **Note:** system 4, 14,15 has no heating mode option, when time heating function is activated, sign  displays on the screen.

Three time - sections can be set for back-up heater

Factory default set:

- The first time - section of heating starts at 04:00 and stops at 05:00 a.m.
- The second time - section of heating starts at 10:00 and stops at 10:00 a.m.
- The third time - section of heating starts at 17:00 and stops at 22:00 p.m.

- For all time - sections, default temperature for control back-up heating is triggered at temperature of 40°C, and stopped at temperature of 50°C.
- If it is needed to deactivate the back-up heating function in one time - section, then just set the start time and stop time with a same value, for example, for the second-time - section, the start time is 10:00 a.m, and the stop time is also 10:00 a.m.
- Within three time - sections, the adjust range of the switch-on temperature is 0°C ~(-OFF-2°C), and the switch-off temperature is (ON+2°C) ~95°C.

SMT Intelligent heating

At the case that solar energy is insufficient to heat the tank, to ensure user has sufficient hot water, controller will check the temperature of tank automatically at the pre-set time, if tank's temperature is not reached to the desired temperature, then back-up heat producer will be triggered, and when tank's temperature rises to the desired value, then back-up heat producer is stopped.

Factory set(not adjustable) of SMT function:

- Default at 13:00 of the first time to trigger the back-up heat device to heat tank to 30 °C,
- Default at 14:00 of the second time to trigger the back-up heat device to heat tank to 35 °C,
- Default at 15:00 of the third time to trigger the back-up heat device to heat tank to 40 °C,
- Default at 16:00 of the fourth time to trigger the back-up heat device to heat tank to 45 °C,
- Default at 17:00 of the fifth time to trigger the back-up heat device to heat tank to 50 °C.
- Diagram of back-up boiler connection (BOIL)

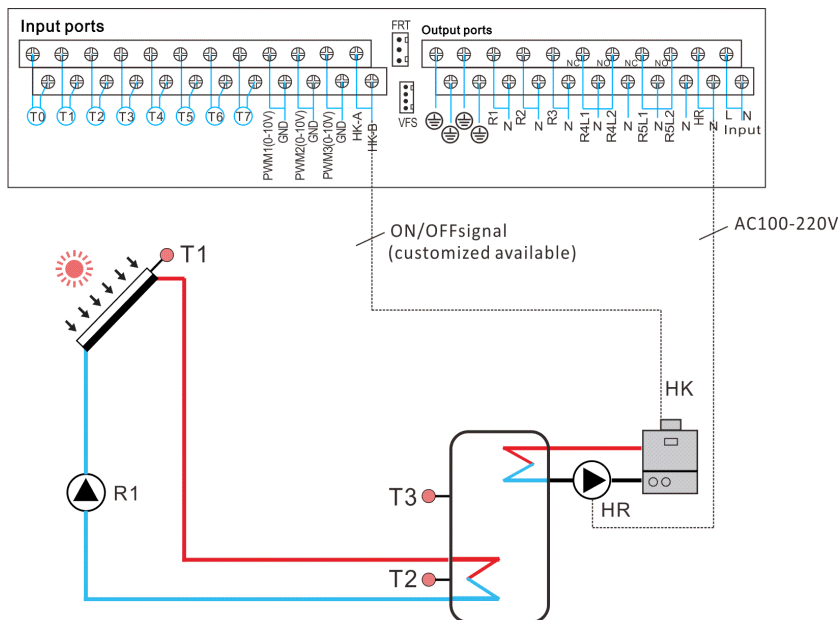

If boiler is selected as back-up heat producer, output HK and HR is controlled by T3 or T2(Optional). When T3 or T2(Optional) is reached to the switch-on temperature of back-up heating function, then back-up heating output HK and HR are triggered, when T3 or T2(Optional) is exceeded the switch-off temperature of back-up heating function, then back-up heating output HK and HR are closed.

i Note: if electrical heater is selected as back-up heater, then according to the power of the heater, an appropriate AC contactor and safety protection device should be installed, we recommend installing the accessory “SR802” (see accessories in paragraph11)

Menu structure					
Main menu	Submenu 1	Submenu 2	Default set	Adjust range	Adjust step
THET					Timed heating function
	MODE		ELET	ELET / BOIL	Heating device select
		THS	T2	T2, T3	Target sensor for timed heating function
		SMT	OFF	ON/OFF	Intelligent heating on or off
		tH1O	04:00/40°C	00:00-23:59/0.0-93°C	Start time and switch-on temperature for the first time-section
		tH1F	05:00/50°C	00:00-23:59/2-95°C	Close time and switch-off temperature for the first time-section
		tH2O	10:00/40°C	00:00-23:59/0.0-93°C	Start time and switch-on temperature for the second time - section
		tH2F	10:00/50°C	00:00-23:59/2-95°C	Close time and switch-off

					temperature for the second time - section
		tH3O	17:00/50°C	00:00-23:59/0.0-93°C	Start time and switch-on temperature for the third time-section
		tH3F	22:00/55°C	00:00-23:59/2-95°C	Close time and switch-off temperature for the third time-section

Function set:

▶ Press “SET” button, access main menu, press “↑” button to select THET timed heating menu



▶ Press “SET” button, “THETOFF” displays



▶ Press “SET” button, “OFF” blinks

▶ Press “↑”, “↓” button to activate the function, “THET ON” displays on the screen



▶ Press “SET” or “ESC” button, to confirm the setting

▶ Press “↑”, “MODE ELET” displays on the screen, select the heater type.



▶ Press “SET” button, “ELET” blinks on the screen.

▶ Press “↑”, “↓” button to select heater type

▶ Press “SET” or “ESC” button, to confirm the setting

▶ Press “↑”, to select the sensor for heating function, “THS T2” displays on the screen



▶ Press “SET” button, “T2” blinks

▶ Press “↑”, “↓” button to select the available sensor

▶ Press “SET” or “ESC” button, to confirm the setting

▶ Press “↑”, to access the intelligent heating window, “SMT OFF” displays on the screen



▶ Press “SET” button, “OFF” blinks

▶ Press “↑”, “↓” button to activate the intelligent heating function, “SMT ON” displays on the screen



▶ Press “SET” or “ESC” button, to confirm the setting

▶ Press “↑”, to access the window of the start time and switch-on temperature setting of heating in the first-time - section, “tH1O 04:00”



displays on the screen

▶ Press “SET” button, hour time zone “04” blinks

▶ Press “↑”, “↓” button to set the hour of the start time of heating in the first-time - section

▶ Press “SET” button, minute time zone “00” blinks

▶ Press “↑”, “↓” button to set the minute of the start time of heating in the first-time - section

▶ Press “↑”, to access the switch-on temperature of heating in the first-time - section, “tH1O 40°C” displays on the screen

▶ Press “SET” button, temperature “40°C” blinks

▶ Press “↑”, “↓” button to adjust the switch-on temperature of heating in the first-time - section

▶ Press “SET” or “ESC” button, to confirm the setting



▶ Press “↑”, to access the window of the close time and switch-off temperature setting of heating in the first-time - section, “tH1F 05:00” displays on the screen

▶ Press “SET” button, hour time zone “05” blinks

▶ Press “↑”, “↓” button to set the hour of the close time of heating in the first-time - section

▶ Press “SET” button, minute time zone “00” blinks

▶ Press “↑”, “↓” button to set the minute of the close time of heating in the first-time - section

▶ Press “↑”, to access the switch-off temperature of heating in the first-time - section, “tH1F 45°C” displays on the screen

▶ Press “SET” button, temperature “45°C” blinks

▶ Press “↑”, “↓” button to adjust the switch-off temperature of heating in the first-time - section

▶ Press “SET” or “ESC” button, to confirm the setting



▶ Press “↑”, to access the window of the start time and switch-on temperature setting for back-up heating in the second time - section, same steps like above description to set the parameters for second and third time - sections.

When the icon of the timed heating  blinks on the screen, it indicates the back-up heating is activated.

(3) CIRC DHW circuit pump controlled by temperature in three time - sections / flow switcher

Note:

1. Because of the system selection, in this system, several auxiliary functions may be allocated

to the same output, for example to R2 output, (see paragraph 4.2 system diagram and its auxiliary functions), then only one function can be activated, other functions are deactivated automatically, and displays “NONE”.

2. And because of system selection, the sensor and relay for a same function may be different.

Function description:

This function is designed to get warm water quickly when customer open the stopcock. In the case stopcock is closed, hot water pipe is also used as the circuit pipe. Two hot water circuit supply modes are available, temperature controlled mode and flow switcher controlled mode. For using this function, an extra circuit pump RX or a flow switcher or a temperature sensor (mounted on the hot water return pipe (TX)) should be installed in the system. (and due to the solar system difference, output relay or sensor input used for circuit pump RX and temperature sensor TX may be different also, see detailed in paragraph 4.2)

2 control mode of DHW circuit pump are designed in this controller: temperature control in three time sections and flow switch control in three time sections.



This sign displays on the screen, it indicates temperature control mode is activated. If this sign blinks, it indicates DHW circuit pump is running.



This sign displays on the screen, it indicates flow switcher control mode is activated. If this sign blinks, it indicates DHW circuit pump is running.



Note:

1. for 2 DHW circuit pump control modes, only one mode can be selected.
2. for 2 DHW control modes, three time - sections/temperature control mode and three time - sections /flow switcher control mode, their parameter adjust steps of two control mode are same.

● **Three time - sections/ temperature control mode TEMP**

Within the time - section (default: DHW temperature is less than 40°C, DHW circuit pump is trigger, when temperature rises to 45°C, DHW circuit pump is stopped).

Trigger on conditions of temperature controlled DHW circuit pump (STAT): when tank temperature (T2 or T3) is 2°C higher than the preset switch-off temperature (CYCF) of this function, DHW pump just can be triggered.

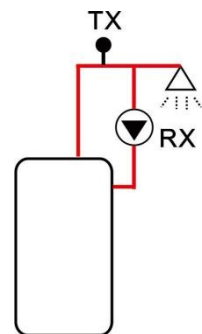

Default time - section set:

- The first time - section: start at 05:00 and stops at 07:00a.m
- The second time - section: starts at 11:00 and stops at 13:00
- The third time - section: starts at 17:00 and stops at 22:00 p.m.

i **Note:** if this sensor is necessary to be installed in the system, in order to avoid the measure error, please ensure its position is 1.5m far to the tank.

● **Three time - sections/ flow switcher control mode CYCFS**

Function description:

Open the stopcock, water flows through pipe, a flow signal is felt by a flow switcher which is mounted on the cold-water pipe and sent to the controller, and then controller will trigger the DHW circuit pump (RX) and it pumps hot water from tank to the circuit pipe. The running time of circuit pump is adjustable, when the preset time runs out, pump stops.

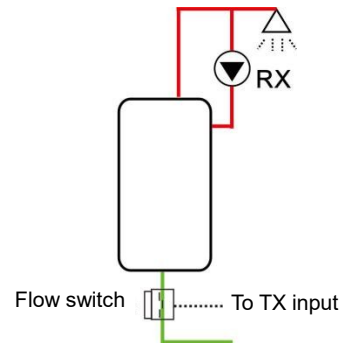

This stopcock seems like a remote controller to control the running of circuit pump. This operation mode is an environment-friendly, energy-saving control solution.

Open the stopcock for a shortly time, the flow switcher which is mounted on the cold flow pipe of tank will feel the flow signal, and then controller will trigger the circuit pump RX, and pump will feed hot water from tank to the pipe. Then when you re-open the stopcock, hot water flows out immediately. Once the pump's running time finishes, then pump is stopped. When hot water is not used, to avoid the heat releasing through pipe due to the running of circuit pump, controller will stop the pump after the pre-set running time. To avoid the pump being re-triggered just after it stopped, parameter "rest time" is used for this control.

Open the stopcock within a pre-set time - section, pump running as the default design: pump running for every three minutes and then rest for 15minutes (the adjustable range of the running time is 1-30 MIN and the rest time is 0-60MIN)

i Note:

- 1.Installed a checkvalve on the inlet pipe of circuit pump to avoid the water which is from tank mixing with water from circuit pipe.
- 2.If the stop time is set with value 0 minute, then when flow switcher feels the flow and thus to trigger the pump, pump will run for the whole time - section. And when the stopcock is closed, pump is stopped automatically.

Default time - section set:

- The first time - section: start at 05:00 and stops at 07:00a.m
- The second time - section: starts at 11:00 and stops at 13:00
- The third time - section: starts at 17:00 and stops at 22:00 p.m.

● **Flow switch fitting:**

Material of fitting: brass

House: plastic

Connection: G3/4

Reed of flow switch: Max 300V DC/1A



i Note:

- 1.Note the flow direction indicated on the flow switch!
- 2.Lead the wires from flow switcher to input ports of controller, no polarity required.
- 3.Flow switch is not included in the delivery list of this controller, please buy it separately.

Menu structure

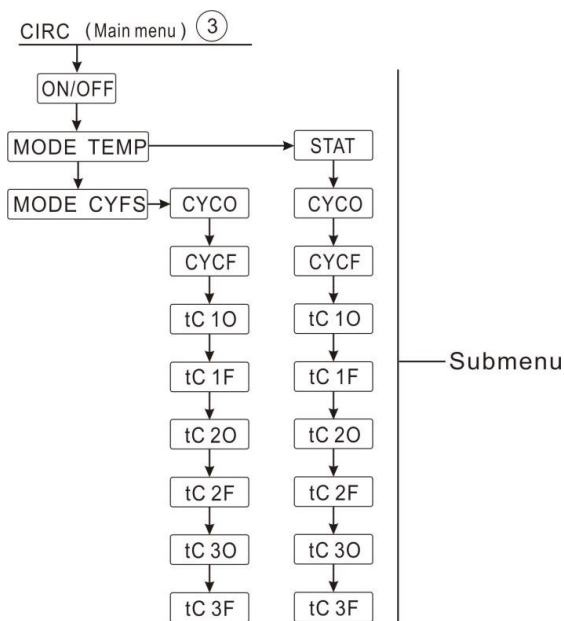

Main menu	Submenu 1	Submenu 2	Default set	Adjust range	Adjust step	Main menu
CIRC			OFF	ON/OFF		DHW circuit function
	MODE		CYFS	CYFS / TEMP		Control mode by temperature or by flow switcher.
		STAT	ON	ON/OFF		Trigger condition of DHW circuit pump Tank temperature (T3 or T2,T3 was priority) is 2°C higher than the switch-off temperature
o		CYCO	40°C/3min	5-53°C/1-30min	0.5 °C /1min	Switch-on temperature or running time
		CYCF	45 °C /15min	7-55°C/0-60min	0.5 °C /1min	Switch-off temperature or the rest time
		t C1O	05:00	00:00-23:59		Start time of the first time-section
		t C1F	07:00	00:00-23:59		Close time of the first time-section
		t C2O	11:00	00:00-23:59		Start time of the second time-section
		t C2F	13:00	00:00-23:59		Close time of the second time-section
		t C3O	17:00	00:00-23:59		Start time of the third time-section
		t C3F	22:00	00:00-23:59		Close time of the third time-section

Function set: (take DHW three time - sections temperature control mode as example)

▶ Press "SET" button, select main menu

CIRC



▶ Press "SET" button, "CIRC OFF" displays on the screen



▶ Press "SET" button, "OFF" blinks

▶ Press "↑", "↓" button to activate the function, "CIRC ON" displays on the screen



▶ Press "SET" or "ESC" button, to confirm the setting

▶ Press "↑", "MODE CYFS" displays on the screen (three time - sections temperature control)



▶ Press "SET" button, "CYFS" blinks

▶ Press "↑", "↓" button to select the temperature control mode

▶ Press "SET" or "ESC" button, to confirm the setting

▶ Press “↑”, “STAT ON” displays on the screen (condition of pump trigger -on, only available at three time - sections temperature control mode)



▶ Press “SET” button, “ON” blinks (default set is ON, activate this function)

▶ Press “↑”, “↓” button to deactivate the function, “STATOFF” displays on the screen



▶ Press “SET” or “ESC” button, to confirm the setting

▶ Press “↑”, “CYCO 40°C” displays on the screen (if flowcontrolmodeCYFSON , then here displays “CYCO 03Min”, heretake temperature as example)



▶ Press “SET” button, “40°C” blinks

▶ Press “↑”, “↓” button to adjust the switch-on temperature of DHW circuit pump, adjustable range 0°C ~ (OFF-2°C)

▶ Press “SET” or “ESC” button, to confirm the setting

▶ Press “↑”, “CYCF 45°C” displays on the screen



▶ Press “SET” button, “45°C” blinks

▶ Press “↑”, “↓” button to adjust the switch-off temperature of DHW circuit pump, adjustable range (ON+2°C) ~OFF

▶ Press “SET” or “ESC” button, to confirm the setting

▶ Press “↑”, “tC10 05:00” displays on the screen, to set the start time of the first time-section.



▶ Press “SET” button, hour time “05” blinks

▶ Press “↑”, “↓” button to adjust time hour of the start time of the first time-section

▶ Press “SET” button, minute time “00” blinks

▶ Press “↑”, “↓” button to adjust time minute of the start time of the first time-section

▶ Press “SET” or “ESC” button, to confirm the setting

▶ Press “↑”, “tC1F 07:00” displays on the screen, to set the close time of the first time-section.



▶ Press “SET” button, hour time “07” blinks

- ▶ Press “↑”, “↓” button to adjust time hour of the close time of the first time-section
 - ▶ Press “SET” button, minute time “00” blinks
 - ▶ Press “↑”, “↓” button to adjust time minute of the close time of the first time-section
 - ▶ Press “SET” or “ESC” button, to confirm the setting

 - ▶ Press “↑”, to access the setting of the start time of the second time-section, doing like above described steps to set the start and close time of second and third time -section.
- If it is needed to close one time - section, then just set the start time and close time with a same time. (example: at 10:00 start circuit, and at 10:00 close the circuit)

7. Function operation and parameter setting (expertise)

(4) PRSWD password

Menu structure			
Main menu	Default set	Adjust range	Description
PRSWD	0000		Enter password

Press” SET” button access the main menu, press “↑” and select “PRSWD 0000”.

Function set:

- ▶ Press “SET” button, the left first digital blinks to ask for entering the password, default password is “0000”
- ▶ Press “↑”, “↓” button to enter the first digital
- ▶ Press “SET” button, the second digital blinks
- ▶ Press “↑”, “↓” button to enter the second digital
- ▶ Press “SET” button, the third digital blinks
- ▶ Press “↑”, “↓” button to enter the third digital
- ▶ Press “SET” button, the fourth digital blinks
- ▶ Press “↑”, “↓” button to enter the fourth digital
- ▶ Press “SET” to access the main menu



Through the password to limit the right of customers to set some important parameters, and four digitals are required to enter, default password is “0000”.

If no password is reset, then please press “SET” five times to access main menu directly.

(5) SYS system selection

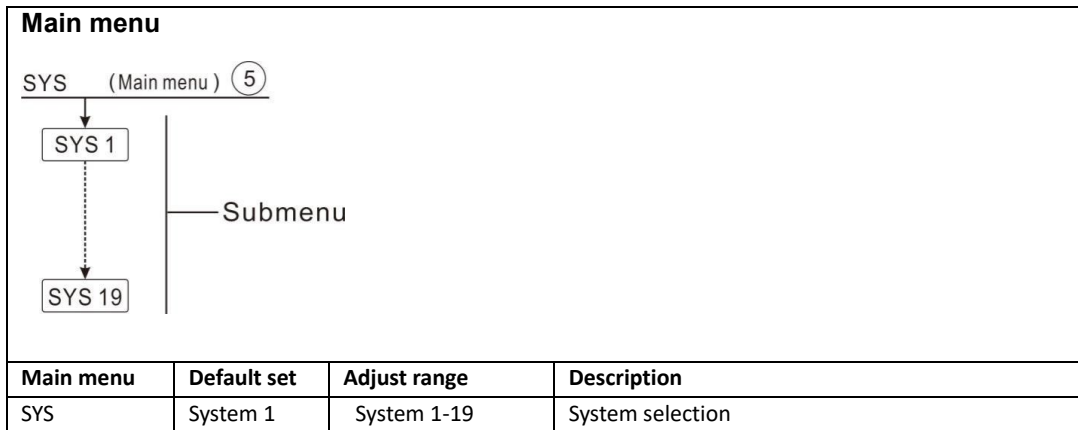

For every system, there are many pre-programmed options and setting, they can be activated or adjusted according the system requirement. 19 systems are available to be selected in this controller.

- ▶ Press “SET” button to select main menu “SYS”
- ▶ Press “SET” button, “SYS 1” displays on the screen
- ▶ Press “SET” button, “1” blinks
- ▶ Press “↑”, “↓” button to select system
- ▶ Press “SET” or “ESC” button, to confirm the setting



(6) (7) LOAD/LOAD2 Tank heating set

Function description:

- **ΔT DT Temperature difference**

The controller works with a standard differential control logic. If the temperature reaches or exceeds the switch-on temperature difference (DTO), the pump switches on. When the temperature difference reaches or falls below the adjusted switch-off temperature difference (DTF), the respective relay switches off.

i Note:

1. The switch-on temperature difference must be 0.5K higher than the switch-off temperature difference. The set temperature difference must be at least 0.5K higher than the switch-on temperature difference.
2. In systems with 2 tanks or tank loading in layers, 2 separate menus (LOAD and LOAD 2) will be displayed.

● **Speed control**

If the temperature reaches or exceeds the switch-on temperature difference, the pump switches on at 100% speed for 10s. Then, the speed is reduced to the minimum pump speed value.

If the temperature difference reaches the set temperature difference DTS, the pump speed increases by one step (10%). The response of the controller can be adapted via the parameter RIS. If the difference increases by the adjustable rise value RIS, the pump speed increases by 10% until the maximum pump speed of 100% is reached. If the temperature difference decreases by the adjustable rise value RIS, pump speed will be decreased by one step 10%.



Note:

To enable speed control, the corresponding pump should be set to (MIN, MAX) and relay control should be set to (PULS, PSOL, PHEA or 0-10 V) (under adjustment menu PUMP).

● **SMAX Maximum tank temperature protection set**

If the tank temperature reaches the pre-set maximum temperature, the tank will no longer be loaded to avoid damage caused by overheating. If the maximum tank temperature is exceeded, Max icon  is displayed and code SMX displays.

The sensor for tank maximum limitation (SMAXS) can be selected. The maximum limitation always refers to the sensor selected. The switch-on hysteresis (HYST) is selectable. Default is 2°C, for example, when tank maximum temperature is set to 70°C, then at 68°C, Maximum tank temperature protection function is deactivated automatically.

Main menu	Submenu	Default Set	Adjust range	Adjust step	Main menu
LOAD					Tank1 loading set
	DTO	6K	1-50K	0.5K	Switch-on temperature of tank 1
	DTF	4K	0.5-49.5K	0.5K	Switch-offtemperatureoftank1
	DTS	10K	1.5-50K	0.5K	Temperature difference for pump speed control
	RIS	2K	1-20K	1K	Temperature increase rate for pump speed control
	SMAX	70°C	4-95°C	1°C	Maximum temperature of tank 1
	SMAXS	T2	T2.T3		Sensor select for maximum temperature of tank 1
	HYST	2K	0.1-10K	0.1K	Temperature hysteresis of maximum temperature of tank 1
LOAD2					Tank2 loading set

	DT2O	6K	1-50K	0.5K	Switch-on temperature of tank 2
	DT2F	4K	0.5-49.5K	0.5K	Switch-offtemperatureoftank2
	DT2S	10K	1.5-50K	0.5K	Temperature difference for pump speed control of tank 2
	RIS2	2K	1-20K	1K	Temperature increase rate of pump speed control of tank 2
	S2MAX	70°C	4-95°C	1°C	Maximum temperature of tank 2
	SMAXS	T4	T4.T5		Sensor select for maximum temperature of tank 2
	HYST2	2K	0.1-10K	0.1K	Temperature hysteresis of maximum temperature of tank 2

Function set:

- ▶ Press “SET” button to select main menu “LOAD”
- ▶ Press “SET” button, “DT06K” displays on the screen
- ▶ Press “SET” button, “6K” blinks
- ▶ Press “↑”, “↓” button to adjust the switch-on temperature difference of the circuit pump.
- ▶ Press “SET” or “ESC” button, to confirm the setting
- ▶ Press “↑” button, “DTF 4K” display on the screen
- ▶ Press “SET” button, “4K” blinks
- ▶ Press “↑”, “↓” button to adjust the switch-off temperature difference of the circuit pump.
- ▶ Press “SET” or “ESC” button, to confirm the setting
- ▶ Press “↑” button, “DTS 10K” display on the screen
- ▶ Press “SET” button, “10K” blinks
- ▶ Press “↑”, “↓” button to adjust the standard temperature difference of the circuit pump.
- ▶ Press “SET” or “ESC” button, to confirm the setting
- ▶ Press “↑” button, “RIS2K” display on the screen
- ▶ Press “SET” button, “2K” blinks
- ▶ Press “↑”, “↓” button to adjust the temperature difference increase rate of the circuit pump.
- ▶ Press “SET” or “ESC” button, to confirm the setting
- ▶ Press “↑” button, “SMAX70°C” display on the screen
- ▶ Press “SET” button, “70°C” blinks
- ▶ Press “↑”, “↓” button to adjust the maximum temperature of tank

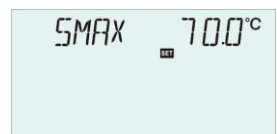
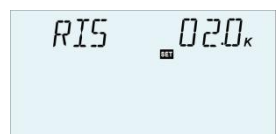
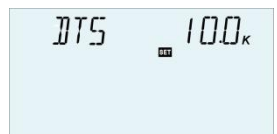

- ▶ Press “SET” or “ESC” button, to confirm the setting
- ▶ Press “↑” button, “SMAXS T2” display on the screen
- ▶ Press “SET” button, “T2” blinks
- ▶ Press “↑”, “↓” button to select sensor used for measuring the maximum temperature of tank.



- ▶ Press “SET” or “ESC” button, to confirm the setting
- ▶ Press “↑” button, “HYST 2K” display on the screen
- ▶ Press “SET” button, “2K” blinks
- ▶ Press “↑”, “↓” button to adjust the hysteresis temperature of the maximum temperature of tank
- ▶ Press “SET” or “ESC” button, to confirm the setting



Load 2 function is set same like above steps.

(8) (9) COL/COL2 Collector function

Function description:

- **OCEM (2) Collector emergency shutdown**

When the collector temperature exceeds the adjusted collector emergency temperature, Then solar pump R1(2) switches off to protect the system components against overheating (collector emergency shutdown). If the maximum collector temperature is exceeded OCEM, Warning icon  displayed and code CEM displays.



Note: In systems with east- / west collectors, 2 separate menus (**COL** and **COL 2**) will be displayed.



Warning! Risk of injury! Risk of system damage by pressure surge! If water is used as the heat transfer fluid in pressure systems, water will boil at 100 °C. Do not set the collector limit temperature higher than 95 °C.

- **OCCO(2) Collector cooling**

The collector cooling function is designed to keep the temperature increase of collector within the operating range by the way of heating tank. If the tank temperature reaches 95 °C, this function will switch off the pump due to safety of system.

When the tank temperature exceeds the pre-set maximum tank temperature, then solar pump is switched off. And then collector temperature may rise, if the collector temperature rises to its maximum temperature, the solar pump is switched on again to transfer the energy from collector to tank, pump keeps running until the collector temperature falls below the maximum

collector temperature, in this heating process, tank temperature may exceed its maximum temperature, but only up to 95°C (emergency shutdown of the tank), both icons



are blinks on the screen and code LEM displays, and then pump is stopped.

If the collector cooling is activated,  is displayed and code CMAX displays.

This function is only available when the system cooling function (OSYC) and the heat transfer function(OHDP) are deactivated.

- **OCMI (2) Collector minimum temperature**

The minimum collector temperature is the lowest switch-on temperature for triggering the solar pumpR1(2), If the collector temperature falls below the minimum temperature,  is displayed and code CMIN displays.

- **OCFR(2)Collector antifreeze function**

When the collector temperature falls below the switch-on temperature **CFRO(2)**of antifreeze function, this function activates the solar pump to circuit system between collector and tank. This will protect the fluid against freezing or coagulating. If collector temperature rises and exceeds the switch-off temperature **CFRF(2)**of anti-freeze function, the solar pump will be switched off.

If collector antifreeze function is activated,  is displayed on the screen.

If collector antifreeze function is running,   are blinks on the screen, and code CFRO displays.



Note:

Since this function uses the limited heat energy stored in the tank, the antifreeze function should be used only in regions with few days of temperatures around the freezing point.

- **OTCO (2)Tube collector function**

This function is used for improving the switch-on behavior in systems with non-ideal sensor positions (e. g. with some tube collectors).

This function operates within a pre-set time - section. It activates the collector circuit pumpR1(2) intermittently to compensate for the delayed temperature measurement caused by

poor sensor position.

If the runtime is set to more than 10s, the pump will run at 100% speed during the first 10s, and pump will run at the minimum speed during the remaining runtime.

If the collector sensor is defective, this function will be switched off.

In 2-collector fields systems, the tube collector function is available for each individual collector field.

In 2-collector fields systems, the tube collector function will affect the inactive collector field only. The solar pump of the active collector field will remain switched on until the switch-off conditions are fulfilled.

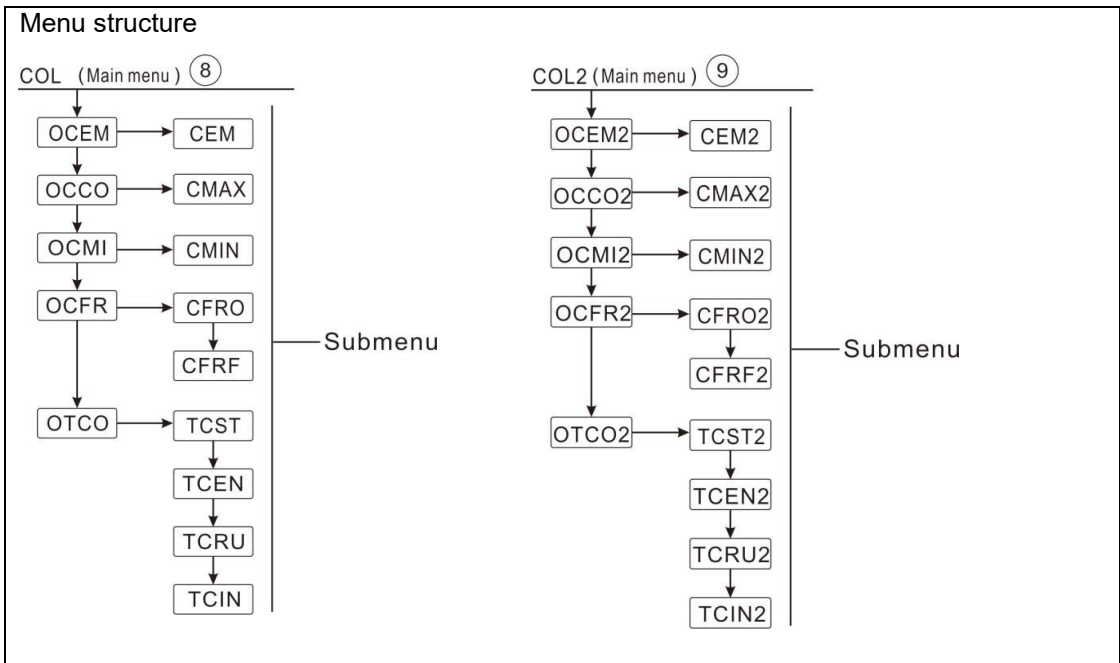

Main menu	Submenu 1	Submenu 2	Default Set	Adjust range	Adjust step	Main menu
COL						Collector function
	OCEM		ON			Emergency shutdown function of collector 1
		CEM	130°C	80-200°C	1°C	Switch-off temperature difference of emergency shutdown of collector 1 (hysteresis 10°C)
	OCCO		OFF			Collector 1 cooling function
		CMAX	110°C	70-160°C	1°C	Collector 1 cooling temperature

						(hysteresis5°C)
	OCMI		OFF			Minimum temperature function of collector 1
		CMIN	10°C	10-90°C	1°C	Minimum temperature of collector 1
	OCFR		OFF			Anti-freeze function of collector 1
		CFRO	4°C	-40-8°C	0.5°C	Switch-on temperature of anti-freeze function of collector 1
		CFRF	5°C	-39-9°C	0.5°C	Switch-off temperature of anti-freeze function of collector 1
	OTCO		OFF			Tube collector function 1
		TCST	07:00	00:00-23:00	1min	Start time of tube collector function 1
		TCEN	19:00	00:00-23:00	1min	Close time of tube collector function 1
		TCRU	30s	30-300s	1s	Run time of tube collector function 1
		TCIN	30min	5-60min	1min	Stop time of tube collector function 1
Main menu	Submenu 1	Submenu 2	Default Set	Adjustrange	Adjust step	Main menu
COL2						Collector 2 function
	OCEM2		ON			Emergency shutdown function of collector 2
		CEM2	130°C	80-200°C	1°C	Switch-off temperature difference of emergency shutdown of collector 2 (hysteresis 20°C)
	OCCO2		OFF			Collector 2coolingfunction
		CMAx2	110°C	70-160°C	1°C	Collector2coolingtemperature (hysteresis5°C)
	OCMI2		OFF			Minimum temperature function of collector 2
		CMIN2	10°C	10-90°C	1°C	Minimum temperature of collector 2
	OCFR2		OFF			Anti-freeze function of collector 2
		CFRO2	4°C	-40-8°C	0.5°C	Switch-on temperature of anti-freeze function of collector 2
		CFRF2	5°C	-39-9°C	0.5°C	Switch-off temperature of anti-freeze function of collector 2
	OTCO2		OFF			Tube collector function 2
		TCST2	07:00	00:00-23:00	1min	Start time of tube collector function 2
		TCEN2	19:00	00:00-23:00	1min	Close time of tube collector function 2
		TCRU2	30s	30-300s	1s	Run time of tube collector function 2
		TCIN2	30min	5-60min	1min	Stop time of tube collector function 2

Function setting:

OCEM(Collector emergency shutdown function)

- ▶ Press “SET” button to select main menu “COL”
 - ▶ Press “SET” button, “OCEM” displays on the screen
 - ▶ Press “SET” button, “OCEM ON” displays on the screen.
 - ▶ Press “SET” button, “ON” blinks
- If to close the function, then press “↑”, “↓” to switch to “OFF”
- ▶ Press “SET” or “ESC” button, to confirm the setting
 - ▶ Press “↑”, “CEM 130°C” displays on the screen
 - ▶ Press “SET” button, “130°C” blinks
 - ▶ Press “↑”, “↓” button to adjust the switch-off temperature of the collector emergency shutdown function
 - ▶ Press “SET” or “ESC” button, to confirm the setting
 - ▶ Press “ESC” button to return to the previous menu

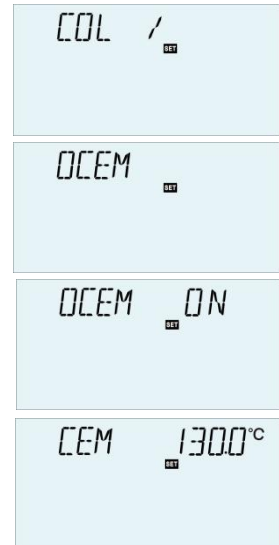

OCCO (Collector cooling function) setting

- ▶ Press “↑”, “OCCO” displays on the screen
- ▶ Press “SET” button, “OCCO OFF” displays on the screen
- ▶ Press “SET” button, “OFF” blinks
- ▶ Press “↑”, “↓” button to activate this function, “OCCO ON” displays on the screen
- ▶ Press “↑”, “CMAX 110°C” displays on the screen
- ▶ Press “SET” button, “110°C” blinks
- ▶ Press “↑”, “↓” button to adjust the collector cooling temperature
- ▶ Press “SET” or “ESC” button, to confirm the setting
- ▶ Press “ESC” button to return to the previous menu



OCMI(Minimum collector temperature) setting

- ▶ Press “↑”, “OCMI” displays on the screen
- ▶ Press “SET” button, “OCMI OFF” displays on the screen
- ▶ Press “SET” button, “OFF” blinks
- ▶ Press “↑”, “↓” button to activate this function, “OCMI ON” displays on the screen
- ▶ Press “↑”, “CMIN 10°C” displays on the screen
- ▶ Press “SET” button, “10°C” blinks



- ▶ Press “↑”, “↓” button to adjust the collector minimum temperature
- ▶ Press “SET” or “ESC” button, to confirm the setting
- ▶ Press “ESC” button to return to the previous menu



OCFR (Anti-freezing function) setting

- ▶ Press “↑”, “OCFR” displays on the screen
- ▶ Press “SET” button, “OCFR OFF” displays on the screen
- ▶ Press “SET” button, “OFF” blinks
- ▶ Press “↑”, “↓” button to activate this function, “OCFR ON” displays on the screen



- ▶ Press “↑”, “CFRO4°C” displays on the screen
- ▶ Press “SET” button, “4°C” blinks
- ▶ Press “↑”, “↓” button to adjust the switch-on temperature of anti-freezing function
- ▶ Press “SET” or “ESC” button, to confirm the setting
- ▶ Press “↑”, “↓” button to activate this function, “OCFR ON” displays on the screen

- ▶ Press “↑”, “CFRF 5°C” displays on the screen
- ▶ Press “SET” button, “5°C” blinks
- ▶ Press “↑”, “↓” button to adjust the switch-off temperature of anti-freezing function



- ▶ Press “SET” or “ESC” button, to confirm the setting
- ▶ Press “ESC” button to return to the previous menu

OTCO (Tube collector function) set

- ▶ Press “↑”, “OTCO” displays on the screen
- ▶ Press “SET” button, “OTCO OFF” displays on the screen
- ▶ Press “SET” button, “OFF” blinks
- ▶ Press “↑”, “↓” button to activate this function, “OTCO ON” displays on the screen



- ▶ Press “↑”, “TCST 07:00” displays on the screen
- ▶ Press “SET” button, hour “07” blinks
- ▶ Press “↑”, “↓” button to adjust time hour of this function
- ▶ Press “SET” button, minute “00” blinks
- ▶ Press “↑”, “↓” button to adjust time minute of this function
- ▶ Press “SET” or “ESC” button, to confirm the setting
- ▶ Press “↑”, “TCEN 19:00” displays on the screen



- ▶ Press “SET” button, hour “19” blinks
- ▶ Press “↑”, “↓” button to adjust time hour of this function
- ▶ Press “SET” button, minute “00” blinks
- ▶ Press “↑”, “↓” button to adjust time minute of this function
- ▶ Press “SET” or “ESC” button, to confirm the setting
- ▶ Press “↑”, “TCRU 30” displays on the screen
- ▶ Press “SET” button, runtime “30” blinks
- ▶ Press “↑”, “↓” button to adjust the runtime (unit: second)
- ▶ Press “SET” or “ESC” button, to confirm the setting
- ▶ Press “↑”, “TCIN 30Min” displays on the screen
- ▶ Press “SET” button, runtime “30” blinks
- ▶ Press “↑”, “↓” button to adjust the stop time (unit: second)
- ▶ Press “SET” or “ESC” button, to confirm the setting
- ▶ Press “ESC” button to return to the previous menu



For COL2 function, its setup steps are same as above description.

(10) PINTV Swimming pool function

This function is designed to improve the operation of swimming pool system, in which sensor position is not ideal.

This function operates within a pre-set time - section. It activates the swimming pool circuit pump R1 or R2 intermittently to compensate for the delayed temperature measurement caused by poor sensor position.

If the runtime is set to more than 10s, the pump will run at 100% speed during the first 10s, and pump will run at the minimum speed during the remaining runtime.

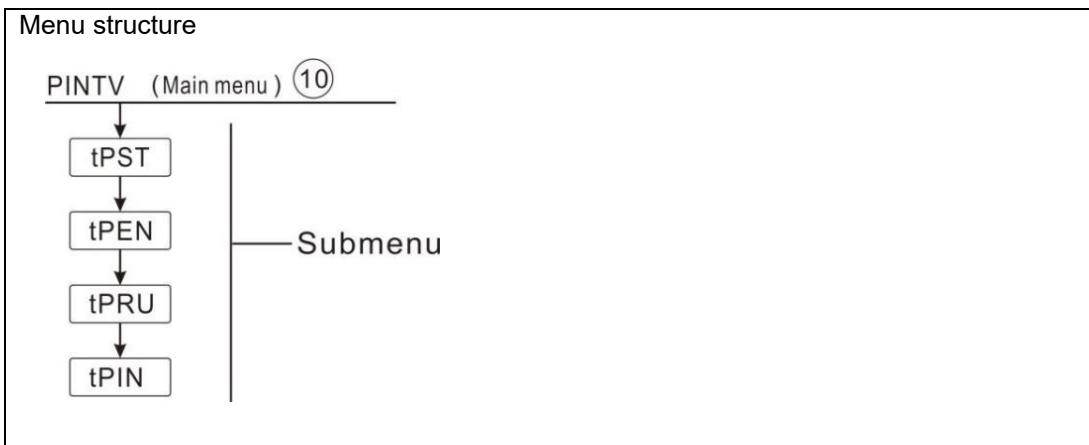

Main menu	Submenu	Default set	Adjust range	Adjust step	Description
PINTV					Swimming pool function
	tPST	00:00	00:00-23:59	30min	Start time of swimming pool function
	tPEN	23:59	00:00-23:59	30min	Stop time of swimming pool function
	tPRU	30S	30-300s	5s	Runtime of swimming pool function
	tPIN	30MIN	5-60min	1min	Stop time of swimming pool function

Function setting:

PINTV(Swimming pool function)

- ▶ Press “SET” button to select main menu “PINTV”
- ▶ Press “SET” button, “PINTVOFF” displays on the screen
- ▶ Press “SET” button, “OFF” displays on the screen
- ▶ Press “↑”, “↓” button, to activate this function, “PINTVON” displays
- ▶ Press “SET” or “ESC” button, to confirm the setting
- ▶ Press “↑”, “tPST 00:00” displays on the screen
- ▶ Press “SET” button, hour “00” blinks
- ▶ Press “↑”, “↓” button to adjust hour of the start time of swimming pool function
- ▶ Press “SET” button, minute “00” blinks
- ▶ Press “↑”, “↓” button to adjust minute of the start time of swimming pool function
- ▶ Press “SET” or “ESC” button, to confirm the setting
- ▶ Press “↑”, “tPEN 23:59” displays on the screen
- ▶ Press “SET” button, hour “23” blinks
- ▶ Press “↑”, “↓” button to adjust hour of the close time of swimming pool function
- ▶ Press “SET” button, minute “59” blinks
- ▶ Press “↑”, “↓” button to adjust minute of the close time of swimming pool function
- ▶ Press “SET” or “ESC” button, to confirm the setting
- ▶ Press “↑”, “tPRU 30” displays on the screen
- ▶ Press “SET” button, time “30” blinks
- ▶ Press “↑”, “↓” button to adjust runtime of the swimming pool function (unit: second)
- ▶ Press “SET” or “ESC” button, to confirm the setting



- ▶ Press “↑”, “tPIN 30MIN” displays on the screen
- ▶ Press “SET” button, time “30” blinks
- ▶ Press “↑”, “↓” button to adjust stop time of the swimming pool function (unit: minute)
- ▶ Press “SET” or “ESC” button, to confirm the setting



(11) PUMP Pump control mode

Function description:

With this parameter, the control mode of pump's relay can be adjusted. The following types can be selected:

- Control mode for standard pump without speed control:
OnOF: Pump on / pump off
- Control mode for standard pump with speed control:
PULS: Burst control via semiconductor relay
- Control mode for high-efficiency pump (HE pump)

• PSOL: PWM signal logic of solar pump

PWM signal logic (solar):

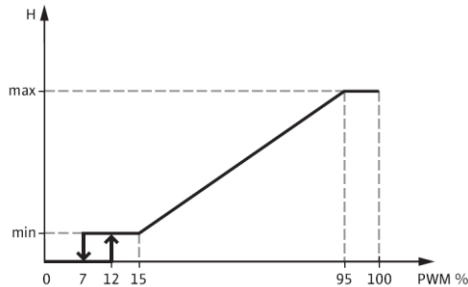

• PHEA: PWM signal logic of heating pump

PWM signal logic (heating):

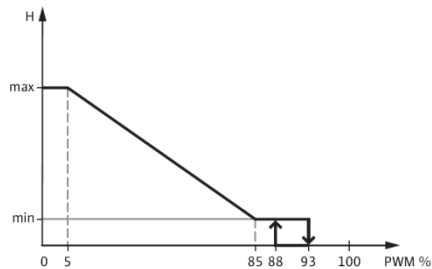

• 0-10: PWM 0 - 10 V signal logic of Speed control

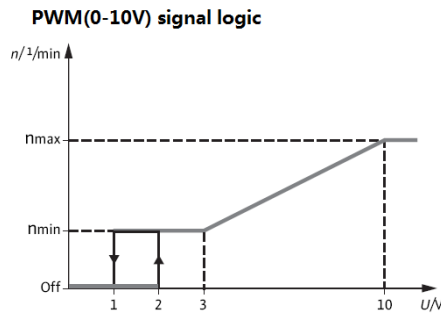

i Note:

1. More information about connection of high efficiency pump see paragraph 3.3
2. **Minimum pump speed:** Under the adjustment menu MIN1 (2, 3), a relative minimum speed for the connected pump can be allocated to the outputs R1(2,3)
3. **Maximum pump speed:** Under the adjustment menu MAX1 (2, 3), a relative maximum speed for the connected pump can be allocated to the outputs R1(2,3)
4. When the devices which are not speed-controlled are used (e. g. valves), the pump speed value of the corresponding relay must be set to 100 % or the control type must be set to ON/OFF to deactivate pump speed control
5. **Allocation for PWM output relay:** a relay can be allocated to a PWM output; PWM1 for R1, PWM2 for R2, PWM3 for R3

Menu structure							
Main menu	Submenu 1	Submenu 2	Submenu 3	Default Set	Adjustment	Adjust step	Description
PUMP							Pump control mode
	PMP1(2,3)						Pump R1(R2, R3) selection
		ONOF		ON	ON/OFF		ON/OFF control of standard pump, (without pump speed adjust)

		PULS		OFF	ON/OFF		Pulse control of standard pump (through semiconductor relay)
			MIN1	50%	20-95%	5%	
			MAX1	100%	25-100%	5%	
		PSOL		OFF	ON/OFF		PWM profile solar pump
			MIN1	50%	20-95%	5%	
			MAX1	100%	25-100%	5%	
		PHEA		OFF	ON/OFF		PWM profile heating pump
			MIN1	50%	20-95%	5%	
			MAX1	100%	25-100%	5%	
		0-10		OFF	ON/OFF		0-10V signal control pump speed
			MIN1	50%	20-95%	5%	
			MAX1	100%	25-100%	5%	

Function set:

- ▶ Press “SET” button to select main menu “PUMP”
- ▶ Press “SET” button, “PMP1” displays on the screen (pump R1 control type selection)
- ▶ Press “SET” button, “ONOF ON” displays on the screen
- ▶ Press “↑”, “↓” button, to select pump control type “PLUS, PSOL, PHEA, 0-10V”
- ▶ After select pump type, press “SET” to access the pump type window
- ▶ Press “SET” button, “OFF” blinks
- ▶ Press “↑”, “↓” button to activate the selected pump type
- ▶ Press “SET” or “ESC” button, to confirm the setting
- ▶ Press “ESC” button to return to the previous menu
- ▶ Press “↑” to access the PMP2 set (pump R2 control mode selection)



Note:

1. PMP2, PMP3 setup step is same as PMP1
 2. only one type can be selected from five types ONOF、PLUS、PSOL、PHEA、0-10V
- Example: if you select “PLUS ON” type, then the others are closed automatically.

(12) LLOGI Tank priority logic

● **Priority logic**

Priority logic is designed for systems with 2-tanks or systems with tank loading in layers; it

determines how the heat is divided between the tanks. Several different priority logic types can be selected:

- Tanks loading in sequence (1 and 2)
- Successive loading (Su 1 and Su 2)
- Parallel loading (0)

- **Tanks heated in sequence (1 and 2)**

If the priority tank is not loaded because its switch-on condition is not reached, then the subordinate tank is checked whether its switch-on condition is reached, if yes, then it is loaded during the circulation runtime (tRUN). After runtime, heating process stops, then break time timer tLB starts to ensure collector to receive more solar energy, during the break time, if the priority tank switch-on condition is still not reached, then the subordinate tank will be loaded again for the circulation runtime.

As soon as the priority tank meets its switch-on condition, controller triggers to heat it immediately, if the priority tank's switch-on condition is still not reached, controller heats the subordinate tank continuously. If the priority tank reaches to its preset temperature, and then tank heated sequence function is stopped.

In systems with 2 tanks or tank loading in layers, all tanks or zones will be heated to its preset temperature firstly (base the priority and sequence control logic). Only when all tanks or zones have exceeded its preset temperature, they just can be heated to their maximum temperature continuously, and it is also heated base the priority and sequence control logic.

If the tank sequence heating function is activated and system is switched to heat the priority tank, then parameter "heating break time" can also act as stabilization time, during which the switch - off temperature difference will be ignored while the system operation stabilizes.

- **Successive loading (Su 1 and Su 2)**

Successive loading means that the priority tank will be heated to its maximum temperature. After the priority tank reaches its maximum temperature, then the second tank will just be heated. If the temperature of the priority tank falls below its pre-set temperature, then the second tank will no longer be heated, regardless of whether the switch-on condition of the priority tank or the second tank is met.

If both tanks are heated to their preset temperature, the same process will occur until the tank reaches its maximum temperature

- **Parallel loading (0)**

In systems with 2 pumps, if parallel loading control logic is selected, 2 tanks will be heated parallelly. In system with 3 - ways valve, tank which temperature is lower will be heated in advance until its temperature is 5K higher than another tank, and then the second tank just can be heated. Two tanks are alternately heated with a 5K temperature difference.

- **OSTS Tank set option (only available at LLOGI/PRIO 1or 2 mode)**

If the priority tank reaches its pre-set temperature, then the subordinate tank will be heated until to its set temperature. After this, priority tank can be loaded to its maximum temperature, and then system is switched to load the subordinate tank. This function is suitable for 2 tanks' system.

- **OSE Spread loading function (only available at LLOGI/PRIO1,2,Su1 or Su2mode)**

In system 5, spread loading function will be activated.

When the spread temperature difference DTSE between collector and priority tank is reached, the second tank will be loaded in parallel unless it is blocked. If the spread temperature difference falls 2K below DTSE temperature, the pump will be switched off. The collector temperature should be higher than the tank temperature.

- **PDELR Pump delay running**

Considering the trigger-on time of the electromagnetic valve this function delays the start of the pump, if this function is activated, corresponding valve relay is triggered firstly, and pump is delayed starting in 20 seconds.

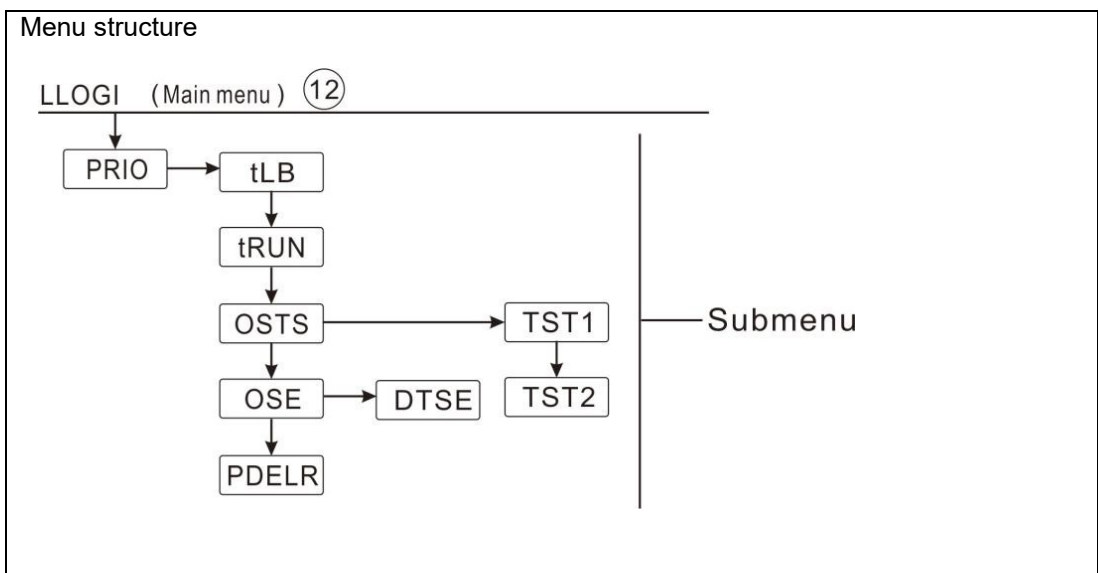

Main menu	Sub menu 1	Sub menu 2	Sub menu 3	Default Set	Adjust range	Adjust step	Description
LLOGI							Tank heating logic
	PRIO			1	1/2/SU1/SU2/0		Tank priority logic
		tLB		2min	1-30min	1min	Heating runtime
		tRUN		15min	1-30min	1min	Heating rest time
		OSTS		OFF	ON/OFF		Tank temperature set option
			TST1	45°C	4-85°C	1°C	Temperature set of tank 1
			TST2	45°C	4-85°C	1°C	Temperature set of tank2
		OSE		OFF	ON/OFF		Spread loading function
			DTSE	40K	20-90K	1K	Spread temperature difference
		PDELR		OFF	ON/OFF		Pump delay running function

Function set:

- ▶ Press “SET” button to select main menu “LLOGI”
- ▶ Press “SET” button, “PRIO 1” displays on the screen (here take PRIO1 as example)
- ▶ Press “SET” button, “1” blinks on the screen
- ▶ Press “↑”, “↓” button, to select tank priority logic
- ▶ Press “SET” or “ESC” button, to confirm the setting
- ▶ Press “↑”, “tLB 2min” displays on the screen
- ▶ Press “SET” button, “2min” blinks on the screen
- ▶ Press “↑”, “↓” button, to adjust the runtime of heating
- ▶ Press “SET” or “ESC” button, to confirm the setting
- ▶ Press “↑”, “tRUN 15min” displays on the screen
- ▶ Press “SET” button, “15min” blinks on the screen
- ▶ Press “↑”, “↓” button, to adjust the break time of heating
- ▶ Press “SET” or “ESC” button, to confirm the setting
- ▶ Press “↑”, “OSTSOFF” displays on the screen
- ▶ Press “SET” button, “OFF” blinks on the screen
- ▶ Press “↑”, “↓” button, to activate tank temperature set function
- ▶ Press “SET” or “ESC” button, to confirm the setting
- ▶ Press “↑”, “TST1 45°C” displays on the screen
- ▶ Press “SET” button, “45°C” blinks on the screen

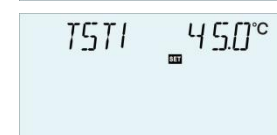

- ▶ Press “↑”, “↓” button, to adjust the temperature of tank 1
- ▶ Press “SET” or “ESC” button, to confirm the setting
- ▶ Press “↑”, “TST2 45°C” displays on the screen
- ▶ Press “SET” button, “45°C” blinks on the screen
- ▶ Press “↑”, “↓” button, to adjust the temperature of tank 2
- ▶ Press “SET” or “ESC” button, to confirm the setting
- ▶ Press “↑”, “OSE OFF” displays on the screen
- ▶ Press “SET” button, “OFF” blinks on the screen
- ▶ Press “↑”, “↓” button, to activate spread loading function
- ▶ Press “SET” or “ESC” button, to confirm the setting
- ▶ Press “↑”, “DTSE 40K” displays on the screen
- ▶ Press “SET” button, “40K” blinks on the screen
- ▶ Press “↑”, “↓” button, to adjust the spread temperature difference
- ▶ Press “SET” or “ESC” button, to confirm the setting
- ▶ Press “↑”, “PDEL R OFF” displays on the screen
- ▶ Press “SET” button, “OFF” blinks on the screen
- ▶ Press “↑”, “↓” button, to activate the pump delay running function
- ▶ Press “SET” or “ESC” button, to confirm the setting
- ▶ Press “ESC” button, to return to the previous menu



(13) COOL Cooling function

Function description:

Different cooling functions for different devices can be activated: system cooling, tank cooling and external radiator heat transfer.

● OSYC System cooling

The system cooling function is designed to keep the solar system operation for a longer time. The function overrides the maximum tank temperature to transfer the energy from collector field to the tank. If the tank temperature is higher than its maximum tank temperature already and the switch-on temperature difference of this function **DTCO** is reached, then the solar pump remains running. Solar loading is continued until either the temperature difference falls below the switch-off temperature DTCF or the collector emergency temperature OCEM reaches

If the system cooling function is running, then  icon displays, and  icon blinks on the screen, code OSYC displays on the screen.



Note: This function will only be available when the collector cooling function, external radiator heat transfer functions are not activated.

- **OSTC Tank cooling**

When the tank cooling function is activated, this function is designed to cool down the tank during the night and provide possibility for solar loading on the following day. If the maximum tank temperature SMAX is exceeded, the collector temperature falls below the tank temperature, and it is below the switch on temperature difference DTCO of this cooling function, then system will be activated to cool down the tank by releasing the energy through the collector in night

If the tank cooling function is running, icon  displays, and icon  blinks on the screen, code OSTC displays.



Note: if tank temperature reaches to 95 °C, all cooling functions will be locked. Hysteresis switch on temperature difference is 5K.

- **OHDP external radiator heat transfer**



Note:

1. According to the selected system, several auxiliary functions are allocated with a same relay output, at this case, then only one of the several auxiliary functions can be activated, the other functions will be deactivated automatically, its function displays "NONE".
2. According the different selected system, see paragraph 4.1, the function will assign to different output ports)

Under strong solar irradiation, external radiator heat transfer function is designed to release the excess thermal energy generated by solar system through an external heat exchanger (e. g. fan coil), aim is to keep the temperature of collector or tank within its operation range. For this function, an extra output RX should be added. (system is different, the output relay of circuit pump RX may be different also, detailed allocation see diagram showed in system description)

External radiator heat transfer function can either control an additional pump or valve (**OTPUM ON** = pump logic, **OTPUM OFF** = valve logic).

Heat transfer by pump logic:

If the collector temperature reaches the switch-on temperature(OTST), the heat transfer pump(RX) on. if the collector temperature falls 5 K below heat transfer temperature(OTST),the

heat transfer pump(RX) off.

Heat transfer by valve logic:

If the collector temperature reaches the switch-on temperature(OTST), the heat transfer valve(RX) and circuit pump(R1) on. if the collector temperature falls 5 K below heat transfer temperature(OTST),the heat transfer valve(RX) and circuit pump(R1) off.

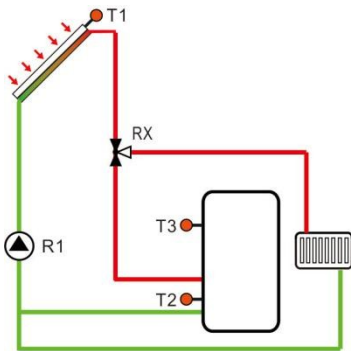

Below is the example of this application for reference.

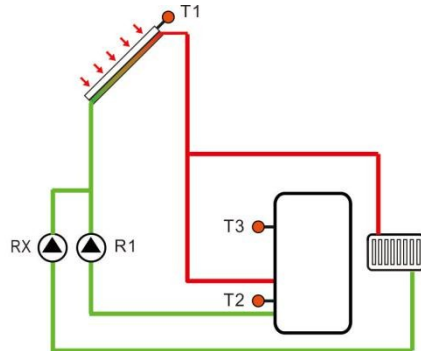

Heat transfer by collector valve logic



Heat transfer by collector pump logic

- Icon  displays on the screen, it indicates that valve heat transfer function is activated.
- Icon  displays on the screen, it indicates that pump heat transfer function is activated.

i Note:

1. The collector over-temperature value **OTST** is blocked 10K lower against the collector emergency temperature **CEM**.
2. This function will only be available when the collector cooling function "OCCO" and the system cooling function "OSYC" are deactivated.

Menu structure

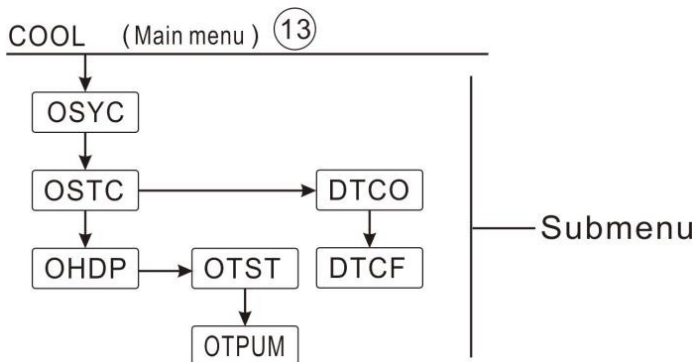

Main menu	Submenu 1	Submenu 2	Default Set	Adjustrange	Adjust step	Description
COOL						Cooling function
	OSYC		OFF	ON/OFF		System cooling
	OSTC		OFF	ON/OFF		Tank cooling
		DTCO	20K	1-30K	0.5K	Switch-on temperature difference of cooling
		DTCF	15K	0.5-29.5K	0.5K	Switch-off temperature difference of cooling
	OHDP		OFF	ON/OFF		Heat transfer – by extra heat exchanger (only available when there is free relay)
		OTST	80°C	20-160°C	1°C	Temperature set of heat transfer (Hysteresis 5°C)
		OTPUM	ON	OTPM ON=pump logic OTPM OFF=valve logic		Pump and valve logic selection

Function set:

● **OSYC System cooling function set**

- ▶ Press “SET” button to select main menu “COOL”
- ▶ Press “SET” button, “OSYC OFF” displays on the screen
- ▶ Press “SET” button, “OFF” blinks on the screen
- ▶ Press “↑”, “↓” button, to activate this cooling function, “OSYC ON” displays on the screen
- ▶ Press “SET” or “ESC” button, to confirm the setting

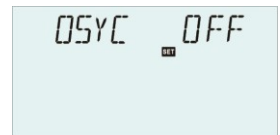

● **OSTC Tank cooling function set**

- ▶ Press “↑”, “OSTC” displays on the screen
- ▶ Press “SET” button, “OSTC OFF” displays on the screen
- ▶ Press “SET” button, “OFF” blinks on the screen
- ▶ Press “↑”, “↓” button, to activate this cooling function, “OSTC ON” displays on the screen
- ▶ Press “SET” or “ESC” button, to confirm the setting
- ▶ Press “↑”, “DTCO20K” displays on the screen
- ▶ Press “SET” button, “20K” blinks on the screen
- ▶ Press “↑”, “↓” button, to adjust the switch-on temperature of cooling function,
- ▶ Press “SET” or “ESC” button, to confirm the setting



- ▶ Press “↑”, “DTCF 15K” displays on the screen
- ▶ Press “SET” button, “15K” blinks on the screen
- ▶ Press “↑”, “↓” button, to adjust the switch-off temperature of cooling function,
- ▶ Press “SET” or “ESC” button, to confirm the setting
- ▶ Press “ESC” button, to return to the previous menu



● **OHDP Heat transfer function set**

- ▶ Press “↑”, “OHDP” displays on the screen
- ▶ Press “SET” button, “OHDP OFF” displays on the screen
- ▶ Press “SET” button, “OFF” blinks on the screen
- ▶ Press “↑”, “↓” button, to activate this cooling function, “OHDP ON” displays on the screen
- ▶ Press “SET” or “ESC” button, to confirm the setting
- ▶ Press “↑”, “OTST 80°C” displays on the screen
- ▶ Press “SET” button, “80°C” blinks on the screen
- ▶ Press “↑”, “↓” button, to adjust the switch-on temperature of heat transfer function,



- ▶ Press “SET” or “ESC” button, to confirm the setting
- ▶ Press “↑”, “OTST 80°C” displays on the screen
- ▶ Press “SET” button, “80°C” blinks on the screen
- ▶ Press “↑”, “↓” button, to adjust the switch-on temperature of heat transfer function,
- ▶ Press “SET” or “ESC” button, to confirm the setting
- ▶ Press “ESC” button, to return to the previous menu



(14) HEATX Energy exchange between tanks



Note: this function is only available in system 3 and system 18.

The heat exchange function is designed to transfer heat from a heat source tank to another heated tank.

The relay is energized when all switch-on conditions below listed are met:

1. The temperature difference between the sensor of heat source tank and heated tank has exceeded the switch-on temperature difference DTHXO.
2. The temperature at the heat source sensor has exceeded its minimum temperature MINHXO
3. The temperature at the heated tank sensor is below its maximum temperature MXHXO.
4. When the set temperature difference is exceeded, pump speed control starts. For every

decrease or increase by the rise value, the pump speed will be adjusted by 10%.

Menu structure					
Main menu	Submenu 1	Default Set	Adjust range	Adjust step	Description
HEATX		OFF	ON/OFF		Heat transfer between tanks
	DTHXO	6K	1-50K	0.5K	Switch-on temperature difference of heat transfer between tanks
	DTHXF	4K	0.5-49.5K	0.5K	Switch-off temperature difference of heat transfer between tanks
	DTHXS	10K	1.5-50K	0.5K	Pump speed control - Temperature difference of two tanks
	RISHX	2K	1-20K	1K	Pump speed control – Temperature increase range of two tanks
	MXHXO	70°C	0.5-95°C	0.5°C	Maximum temperature of heated tank(Hysteresis 2°C)
	MNHXO	60°C	0.5-89.5°C	0.5°C	Minimum temperature of heat source tank (Hysteresis 2°C)

Function set:

- ▶ Press “SET” button to select main menu “HEATX”
- ▶ Press “SET” button, “DTHXO6K” displays on the screen
- ▶ Press “SET” button, “6K” blinks on the screen
- ▶ Press “↑”, “↓” button, to adjust the switch-on temperature difference of heat transfer between 2 tanks
- ▶ Press “SET” or “ESC” button, to confirm the setting



- ▶ Press “↑”, “DTHXF 4K” displays on the screen
- ▶ Press “SET” button, “4K” blinks on the screen
- ▶ Press “↑”, “↓”button, to adjust the switch-off temperature difference of heat transfer between 2 tanks
- ▶ Press “SET”or “ESC” button, to confirm the setting
- ▶ Press “↑”, “DTHXS 10K” displays on the screen
- ▶ Press “SET” button, “10K” blinks on the screen
- ▶ Press “↑”, “↓”button, to adjust the standard temperature difference of circuit pump
- ▶ Press “SET”or “ESC” button, to confirm the setting
- ▶ Press “↑”, “RISHX2K” displays on the screen
- ▶ Press “SET” button, “2K” blinks on the screen
- ▶ Press “↑”, “↓”button, to adjust the temperature increase range
- ▶ Press “SET”or “ESC” button, to confirm the setting
- ▶ Press “↑”, “MXHXO70°C” displays on the screen
- ▶ Press “SET” button, “70°C” blinks on the screen
- ▶ Press “↑”, “↓”button, to adjust the maximum temperature of heated tank
- ▶ Press “SET”or “ESC” button, to confirm the setting
- ▶ Press “↑”, “MINHXO 60°C” displays on the screen
- ▶ Press “SET” button, “60°C” blinks on the screen
- ▶ Press “↑”, “↓”button, to adjust the minimum temperature of heat source tank
- ▶ Press “SET”or “ESC” button, to confirm the setting
- ▶ Press “ESC”, to return the previous menu



(15) RPH Heating return pipe preheat

Function description:

i **Note:** this function is available in system 10,11,12,19

The heating return pipe preheat function is designed to transfer energy from a heat source to the heating circuit return.

The relay is energized when both switch-on conditions are met:

- The temperature difference between the sensor of heat source tank and sensor of the heating circuit return has exceeded the switch-on temperature difference DTRPO.
- The temperature at the heating circuit return has exceeded its minimum temperature MNRPH, the switch-on hysteresis is -5 K.

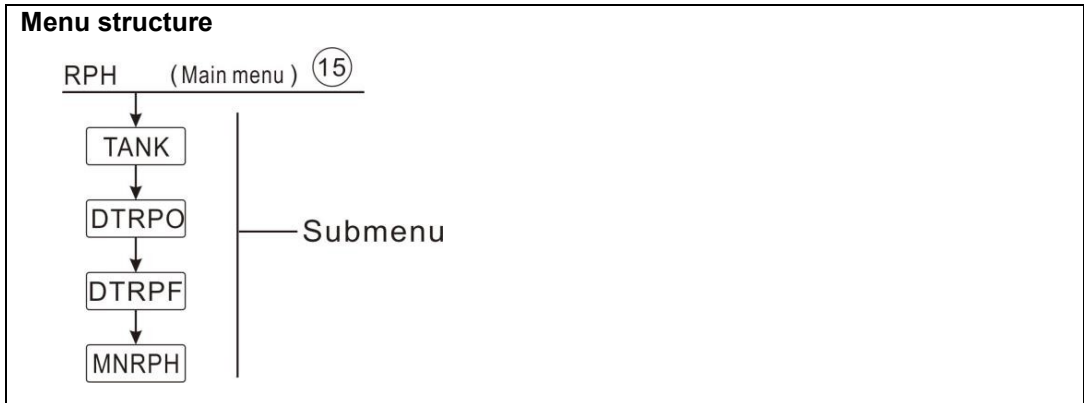

Main menu	Submenu 1	Default Set	Adjust range	Adjust step	Description
RPH		OFF	ON/OFF		Heating return pipe heat function
	TANK	T4	T2,T3,T4		Tank sensor selection
	DTRPO	6K	1-50K	0.5K	Switch-on temperature difference
	DTRPF	4K	0.5-49.5K	0.5K	Switch-on temperature difference
	MNRPH	30°C	1.5-89.5°C	0.5°C	Minimum temperature of heating return pipe (hysteresis 5°C)

Function set:

- ▶ Press “SET” button to select main menu “RPH”
- ▶ Press “SET” button, “TANK T4” displays on the screen
- ▶ Press “SET” button, “T4” blinks on the screen
- ▶ Press “↑”, “↓” button, to select the sensor for heating return pipe heat function
- ▶ Press “SET” or “ESC” button, to confirm the setting
- ▶ Press “↑”, “DTRPO6K” displays on the screen
- ▶ Press “SET” button, “6K” blinks on the screen
- ▶ Press “↑”, “↓” button, to adjust the switch-on temperature
- ▶ Press “SET” or “ESC” button, to confirm the setting
- ▶ Press “↑”, “DTRPF4K” displays on the screen
- ▶ Press “SET” button, “4K” blinks on the screen
- ▶ Press “↑”, “↓” button, to adjust the switch-off temperature
- ▶ Press “SET” or “ESC” button, to confirm the setting
- ▶ Press “↑”, “MNRPH30°C” displays on the screen
- ▶ Press “SET” button, “30°C” blinks on the screen
- ▶ Press “↑”, “↓” button, to adjust the minimum temperature of heating return pipe
- ▶ Press “SET” or “ESC” button, to confirm the setting



(16) DLHTX Thermal energy transferring between 2 tanks

i Note: this function is only available in system 13.

Function description:

● **Thermal energy transferred from tank 1 to tank 2**

When tank 1 temperature reaches to the switch-on temperature (L1H2O), and temperature of tank 1 is higher than tank 2's, thermal energy will be transferred from tank 1 to tank 2, circuit pump R2 is triggered. When tank 1 temperature reaches to the switch-off temperature (L1H2F) or temperature of tank2 rises to the temperature of tank 1, or tank2's temperature reaches its maximum S2MAX, then circuit pump R2 is stopped.

● **Thermal energy transferred from tank 2 to tank 1**

When tank 2 temperature reaches to the switch-on temperature (L2H1O), and temperature of tank 2 is higher than tank 1's, thermal energy will be transferred from tank 2 to tank 1, circuit pump R3 is triggered. When tank 2 temperature reaches to the switch-off temperature (L2H1F) or temperature of tank 1 rises to the temperature of tank 2, or tank1's temperature reaches its maximum SMAX, then circuit pump R3 is stopped.



Main menu	Submenu 1	Default Set	Adjustrange	Adjust step	Description
DLHTX					Thermal energy transferring between 2 tanks
	L1H2O	80°C	60°C~90°C	0.5°C	Switch-on temperature difference for heat transfer from tank1 to tank 2
	L1H2F	60°C	0°C~ON-2°C	0.5°C	Switch-off temperature difference for heat transfer from tank1 to tank 2
	L2H1O	60°C	30°C~60°C	0.5°C	Switch-on temperature difference for heat transfer from tank2 to tank1
	L2H1F	40°C	0°C~ON-2°C	0.5°C	Switch-off temperature difference for heat transfer from tank2 to tank 1

Function set:

- ▶ Press “SET” button to select main menu “DLHTX”
- ▶ Press “SET” button, “L1H2O 80°C” displays on the screen
- ▶ Press “SET” button, “80°C” blinks on the screen
- ▶ Press “↑”, “↓” button, to adjust the switch-on temperature of heat transfer from tank 1 to tank 2



- ▶ Press “SET” or “ESC” button, to confirm the setting
- ▶ Press “↑” button, “L1H2F60°C” displays on the screen
- ▶ Press “SET” button, “60°C” blinks on the screen
- ▶ Press “↑”, “↓” button, to adjust the switch-off temperature of heat transfer from tank 1 to tank 2



- ▶ Press “SET” or “ESC” button, to confirm the setting
- ▶ Press “↑” button, “L2H1O 60°C” displays on the screen
- ▶ Press “SET” button, “60°C” blinks on the screen
- ▶ Press “↑”, “↓” button, to adjust the switch-on temperature of heat transfer from tank 2 to tank 1



- ▶ Press “SET” or “ESC” button, to confirm the setting
- ▶ Press “↑” button, “L2H1F 40°C” displays on the screen
- ▶ Press “SET” button, “40°C” blinks on the screen
- ▶ Press “↑”, “↓” button, to adjust the switch-off temperature of heat transfer from tank 2 to tank 1



- ▶ Press “SET” or “ESC” button, to confirm the setting

(17) EXHX External heat exchanger control function

 Note: this function is only available in system 4, system 15 and 16.

External heat exchanger function: when temperature difference between collector and tank rises up to the switch-on temperature difference DTO, circuit pump R1 is triggered to heat the external heat exchanger. When temperature difference between heat exchanger and tank rises to the switch-on temperature DTEXO, and temperature of heat exchanger is higher than the lowest switch-on temperature (MNEEXO), then circuit pump R2 is triggered to heat tank.

When temperature difference between collector and tank drops to the switch-off temperature DTF or temperature of the heat exchanger rises to its maximum switch-off temperature (MXEXO), then circuit pump R1 is stopped.

When temperature difference between heat exchanger and tank drops to the switch-off temperature DTEXF or temperature of heat exchanger drops below its minimum switch-on temperature (MNEXO), then circuit pump R2 is stopped.

Note: when no sensor is installed on the external heat exchanger or the sensor is damaged, and when temperature difference between collector and tank reaches its switch-on temperature difference (DTO), then circuit pump R1, R2 are triggered simultaneously. And when temperature difference drops to the switch-off temperature difference (DTF), then R1, R2 are stopped simultaneously.

When the temperature difference exceeds its preset value, pump speed control function starts, when value increases a step or reduces a step, pump speed is changed by 10% per step.

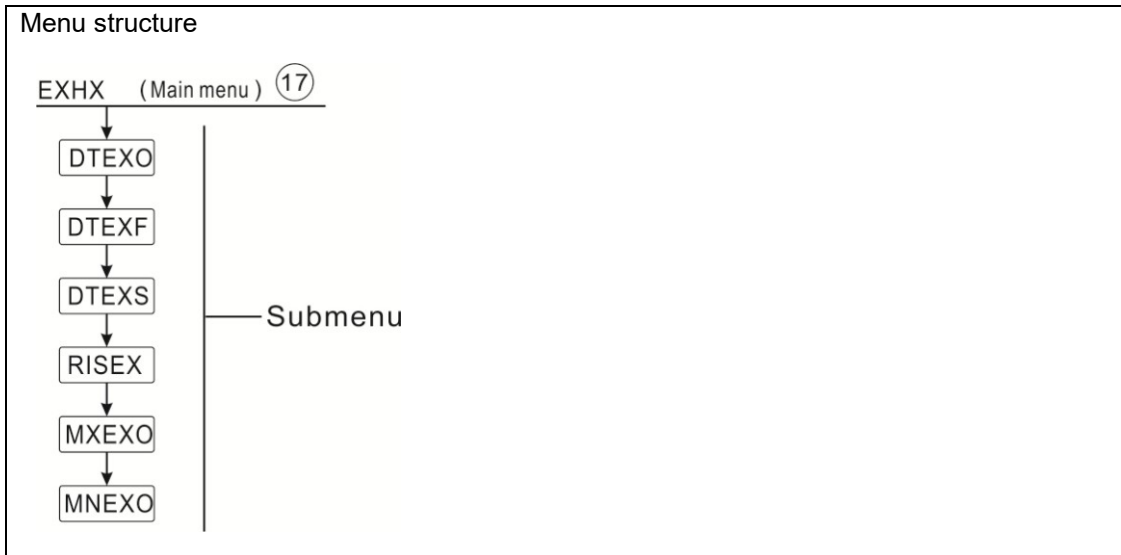

Main menu	Submenu 1	Default Set	Adjust range	Adjust step	Description
EXHX					External heat exchanger control function
	DTEXO	5K	1-50K	0.5K	R2 switch-on temperature difference
	DTEXF	3K	0.5-49.5K	0.5K	R2 switch-off temperature difference
	DTEXS	10K	1.5-50K	0.5K	Pump speed control- set the temperature difference
	RISEX	2K	1-20K	1K	Pump speed control- set the increase range
	MXEXO	80 °C	0.5-95 °C	0.5 °C	Maximum switch-off temperature of external heat exchanger (hysteresis 2°C)

	MNEXO	30 °C	0.5-93 °C	0.5 °C	Maximum switch-on temperature of external heat exchanger (hysteresis 2°C)
--	-------	-------	-----------	--------	---

Functionset:

- ▶ Press “SET” button to select main menu “THET”
- ▶ Press “SET” button, “DTEXO 5K” displays on the screen
- ▶ Press “SET” button, “5K” blinks on the screen
- ▶ Press “↑”, “↓” button, to adjust the switch-on temperature difference
- ▶ Press “SET” or “ESC” button, to confirm the setting
- ▶ Press “↑” button, “DTEXF3K” displays on the screen
- ▶ Press “SET” button, “3K” blinks on the screen
- ▶ Press “↑”, “↓” button, to adjust the switch-off temperature difference
- ▶ Press “SET” or “ESC” button, to confirm the setting
- ▶ Press “↑” button, “DTEXS10K” displays on the screen
- ▶ Press “SET” button, “10K” blinks on the screen
- ▶ Press “↑”, “↓” button, to adjust the standard temperature difference of pump
- ▶ Press “SET” or “ESC” button, to confirm the setting
- ▶ Press “↑” button, “RISEX2K” displays on the screen
- ▶ Press “SET” button, “2K” blinks on the screen
- ▶ Press “↑”, “↓” button, to adjust the increase range
- ▶ Press “SET” or “ESC” button, to confirm the setting
- ▶ Press “↑” button, “MXEXO80°C” displays on the screen
- ▶ Press “SET” button, “80°C” blinks on the screen
- ▶ Press “↑”, “↓” button, to adjust the maximum switch-off temperature of external heat exchanger
- ▶ Press “SET” or “ESC” button, to confirm the setting
- ▶ Press “↑” button, “MNEXO30°C” displays on the screen
- ▶ Press “SET” button, “30°C” blinks on the screen
- ▶ Press “↑”, “↓” button, to adjust the minimum switch-on temperature of external heat exchanger
- ▶ Press “SET” or “ESC” button, to confirm the setting
- ▶ Press “ESC” button, to return to the previous menu



(18) SFB Solid fuel boiler function

i Note:

1. According to the different selected system, several auxiliary functions may be assigned to a same output, then only one auxiliary function can be triggered, others will be deactivated automatically, and its function displays "NONE".
2. According to the different selected system, this function will be assigned to the different object sensors and output ports

The solid fuel boiler function is designed to transfer heat from a solid fuel boiler to a tank, for this function, any sensor input and output relay are needed.

The relay is energized when all switch-on conditions are met:

- The temperature difference between the sensors of solid fuel boiler and heated tank exceeds the switch-on temperature difference.
- The temperature at the solid fuel boiler sensor exceeds its minimum temperature (MINSFO)
- The temperature at the heated tank is lower than its maximum temperature (MXSFS)

When the preset temperature difference is exceeded, pump speed control starts. For every increase or decrease by the rise value, the pump speed will be adjusted by 10 %.

The switch-on hysteresis is -5 K.

i Note: sensor on the upper part of the heated tank is the priority sensor, if on the upper part no sensor is installed or sensor is damaged, then controller will take the signal from bottom sensor automatically.

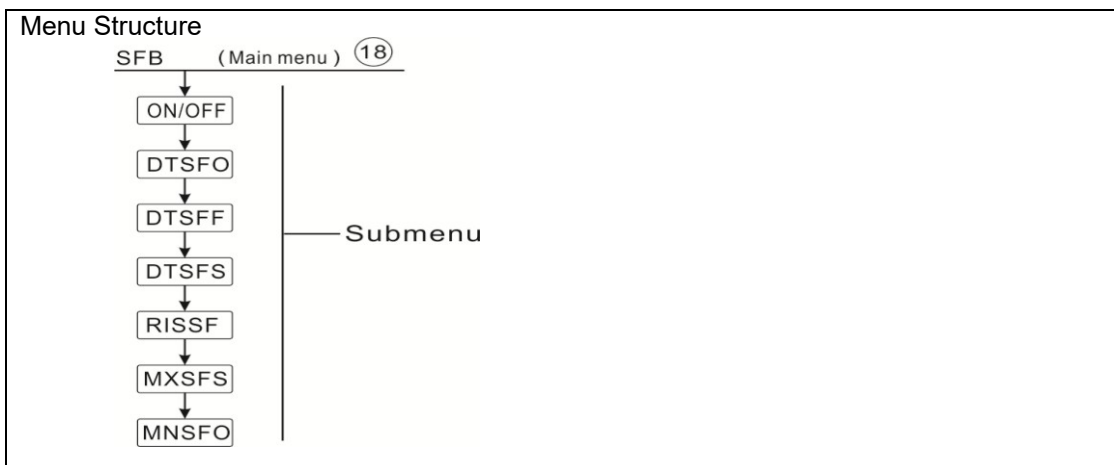

Mainmenu	Submenu 1	Default Set	Adjustrange	Adjust step	Description
SFB		OFF	ON/OFF		Solid fuel boiler function
	DTSFO	6K	1-50K	0.5K	Switch-on temperature difference
	DTSFF	4K	0.5-49.5K	0.5K	Switch-off temperature difference
	DTSFS	10K	1.5-50K	0.5K	Pump speed control – temperature difference set
	RISSF	2K	1-20K	1K	Pump speed control – temperature increase rate
	MXSFS	60°C	0.5-95°C	0.5°C	Maximum temperature of heated tank (hysteresis 2°C)
	MNSFO	60°C	0.5-89.5°C	0.5°C	Minimum temperature of solid fuel boiler (hysteresis 2°C)

Function set:

- ▶ Press “SET” button to select main menu “SFB”
- ▶ Press “SET” button, “SFB OFF” displays on the screen
- ▶ Press “SET” button, “OFF” blinks on the screen
- ▶ Press “↑”, “↓” button, to activate this function
“SFBON” displays on the screen
- ▶ Press “SET” or “ESC” button, to confirm the setting
- ▶ Press “↑” button, “DTSFO 6K” displays on the screen
- ▶ Press “SET” button, “6K” blinks on the screen
- ▶ Press “↑”, “↓” button, to adjust the switch-on temperature difference
- ▶ Press “SET” or “ESC” button, to confirm the setting
- ▶ Press “↑” button, “DTSSF 4K” displays on the screen
- ▶ Press “SET” button, “4K” blinks on the screen
- ▶ Press “↑”, “↓” button, to adjust the switch-off temperature difference
- ▶ Press “SET” or “ESC” button, to confirm the setting
- ▶ Press “↑” button, “DTSFS 10K” displays on the screen
- ▶ Press “SET” button, “10K” blinks on the screen
- ▶ Press “↑”, “↓” button, to adjust the standard temperature difference for pump circuit
- ▶ Press “SET” or “ESC” button, to confirm the setting
- ▶ Press “↑” button, “RISSF 2K” displays on the screen
- ▶ Press “SET” button, “2K” blinks on the screen
- ▶ Press “↑”, “↓” button, to adjust temperature increase rate
- ▶ Press “SET” or “ESC” button, to confirm the setting



- ▶ Press “↑” button, “MXSFS 60°C” displays on the screen
- ▶ Press “SET” button, “60°C” blinks on the screen
- ▶ Press “↑”, “↓” button, to adjust the switch-off temperature (maximum) of heated tank



- ▶ Press “SET” or “ESC” button, to confirm the setting
- ▶ Press “↑” button, “MNSFO 60°C” displays on the screen
- ▶ Press “SET” button, “60°C” blinks on the screen
- ▶ Press “↑”, “↓” button, to adjust the minimum switch-on temperature of solid fuel boiler
- ▶ Press “SET” or “ESC” button, to confirm the setting
- ▶ Press “ESC” button, to return to the previous menu



(19) AUXiliary functions

 Note: in a system, if several auxiliary functions are all allocated to output R5 (see system description), then only one auxiliary function can be activated, others function will be deactivated automatically, and these functions displays “NONE”

Depend on the selected system; following functions may be triggered.

- **TIMER (Timer function)**

(According the different selected system, this function will be assigned to the different output ports)

Timer function can trigger controller’s output port at the pre-set time; therefore, an available output is needed.

When  display on the screen, it’s mean that TIMER function is activate. When the icon flashes, it means that the function is running.

- **AH Thermostat function**

(According the different selected system, this function will be assigned to the different object sensor and output port)

The thermostat function is independent from the solar operation system, it can e. g.be used for using surplus energy or for back-up heating. (Every day 3 heating time - sections can be set)

 **Note:**

1. AH O < AH F: Thermostat function used for back-up heating
2. AH O > AH F: Thermostat function used for releasing surplus energy from tank.
3. Icon AH displays on the screen, it means thermostat function for back-up heating is

activated. AH flashes, it indicates this function is running.

4. Icon  displays on the screen, it means thermostat function for heating release is activated, icon flashes, it means that function is running.

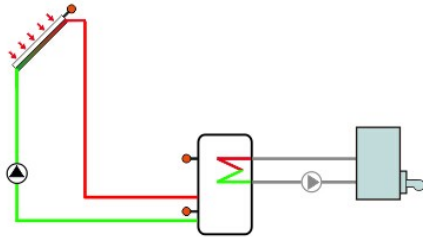

Back-up heating

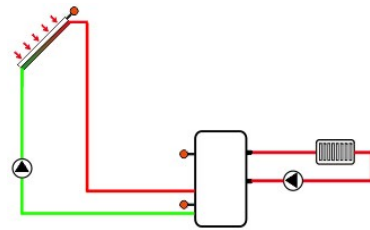

Surplus energy releasing

● **BEEP Beeper fault warning**

When system has fault (temperature sensor fault, no flow), beeper will send warning.

Menu structure

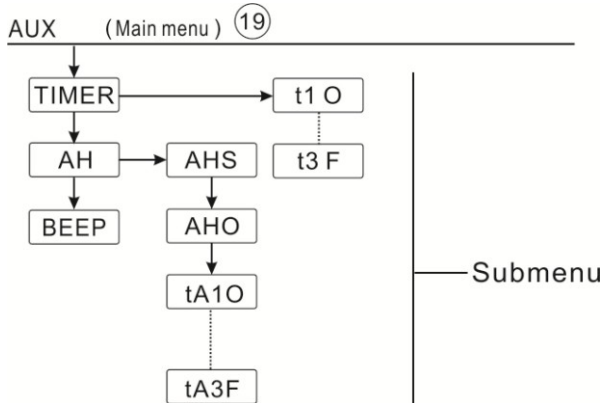

Main menu	Submenu 1	Submenu 2	Default Set	Adjustrange	Adjust step	Description
AUX						Auxiliary function
	TIMER		OFF	ON/OFF		Timer function
		t 1O	00:00	00:00-23:59		Start time of the first time-section
		t 1F	00:00	00:00-23:59		Close time of the first time-section
		t 2O	00:00	00:00-23:59		Start time of the second time-section
		t 2F	00:00	00:00-23:59		Close time of the second first time-section
		t 3O	00:00	00:00-23:59		Start time of the third time-section
		t 3F	00:00	00:00-23:59		Close time of the third time-section
	AH		OFF	ON/OFF		Thermostat function
		AHS	T3	T2/T3/T4		Target sensor for thermostat function
		AHO	40°C	0.0-95°C	0.5°C	Switch-on temperature

	AHF	45°C	0.0-94.5°C	0.5°C	Switch-off temperature
	t A1O	00:00	00:00-23:59		Start time of the first time-section
	t A1F	23:59	00:00-23:59		Close time of the first time- section
	t A2O	00:00	00:00-23:59		Start time of the second time-section
	t A2F	00:00	00:00-23:59		Close time of the second first time-section
	t A3O	00:00	00:00-23:59		Start time of the third time-section
	t A3F	00:00	00:00-23:59		Close time of the third time- section
BEEP		OFF	ON/OFF		Beeper warning function (sensor error, no flow)

● **TIMER Timer function set**

▶ Press “SET” button to select submenu “TIMER”, “TIMER” displays on the screen



▶ Press “SET” button, “TIMEROFF” blinks on the screen

▶ Press “SET” button, “OFF” blinks on the screen

▶ Press “↑”, “↓” button, to activate this function “TIMERON” displays on the screen



▶ Press “SET” or “ESC” button, to confirm the setting

▶ Press “↑” button, “t1O00:00” displays on the screen

▶ Press “SET” button, hour time “00” blinks on the screen

▶ Press “↑”, “↓” button, to adjust the hour of start time of the first time - section



▶ Press “SET” button, minute time “00” blinks on the screen

▶ Press “↑”, “↓” button, to adjust the minute of start time of the first time - section

▶ Press “SET” or “ESC” button, to confirm the setting

▶ Press “↑” button, “t1F 00:00” displays on the screen

▶ Press “SET” button, hour time “00” blinks on the screen

▶ Press “↑”, “↓” button, to adjust the hour of close time of the first time - section



▶ Press “SET” button, minute time “00” blinks on the screen

▶ Press “↑”, “↓” button, to adjust the minute of close time of the first time - section

▶ Press “SET” or “ESC” button, to confirm the setting

▶ Press “↑” button, access the second time-section set, do same as above steps, to set the time for the second and third time-section

If it is needed to deactivate a time-section, just set the start time and close time with same time (for example: 10:00 starts and 10:00 closes also)

● **AH Auto magical thermostat function**

▶ Press “SET” button to select submenu “AH”, “AH” displays on the screen



▶ Press “SET” button, “AH OFF” blinks on the screen

▶ Press “SET” button, “OFF” blinks on the screen



▶ Press “↑”, “↓” button, to activate this function “AHON” displays on the screen

▶ Press “SET” or “ESC” button, to confirm the setting

▶ Press “↑” button, “AHS T3” displays on the screen



▶ Press “SET” button, “T3” blinks on the screen

▶ Press “↑”, “↓” button, to select the desired sensor for thermostat function

▶ Press “SET” or “ESC” button, to confirm the setting

▶ Press “↑” button, “AHO 40°C” displays on the screen



▶ Press “SET” button, “40°C” blinks on the screen

▶ Press “↑”, “↓” button, to adjust the switch-on temperature of thermostat function

▶ Press “SET” or “ESC” button, to confirm the setting

▶ Press “↑” button, “AHF 45°C” displays on the screen



▶ Press “SET” button, “45°C” blinks on the screen

▶ Press “↑”, “↓” button, to adjust the switch-off temperature of thermostat function

▶ Press “SET” or “ESC” button, to confirm the setting

▶ Press “↑” button, “tA1O 00:00” displays on the screen



▶ Press “SET” button, hour “00” blinks on the screen

▶ Press “↑”, “↓” button, to adjust hour of the start time of the first time - section of thermostat function

▶ Press “SET” button, minute “00” blinks on the screen

▶ Press “↑”, “↓” button, to adjust minute of the start time of the first time - section of thermostat function

▶ Press “SET” or “ESC” button, to confirm the setting

▶ Press “↑” button, “tA1F 23:59” displays on the screen



▶ Press “SET” button, hour “23” blinks on the screen

▶ Press “↑”, “↓” button, to adjust hour of the close time of the first time - section of thermostat function

▶ Press “SET” button, minute “59” blinks on the screen

▶ Press “↑”, “↓” button, to adjust minute of the close time of the first time - section of

thermostat function

▶ Press “SET” or “ESC” button, to confirm the setting

▶ Press “↑” button, access the second time-section set, do same like above steps, to set the time for the second and third time-section

If it is needed to deactivate a time-section, just set the start time and close time with same time (for example: 10:00 starts and 10:00 closes also)

● **BEEP Beeper warning function set**

▶ Press “SET” button to select submenu “BEEP”, “BEEP” displays on the screen



▶ Press “SET” button, “BEEPOFF” blinks on the screen

▶ Press “SET” button, “OFF” blinks on the screen

▶ Press “↑”, “↓” button, to activate this function “BEEPON” displays on the screen



▶ Press “SET” or “ESC” button, to confirm the setting

(20) MAN Manual mode

For control and service work, the operating mode of the relays (outputs R1, R2, R3, R4, R5, HR) can be manually adjusted, manual output “On/OFF”

i **Note:** if manual mode is activated, (M) icon blinks on the screen, controller runs for 15 minutes and then switch-off all outputs, control exits manual mode automatically.

Menu structure

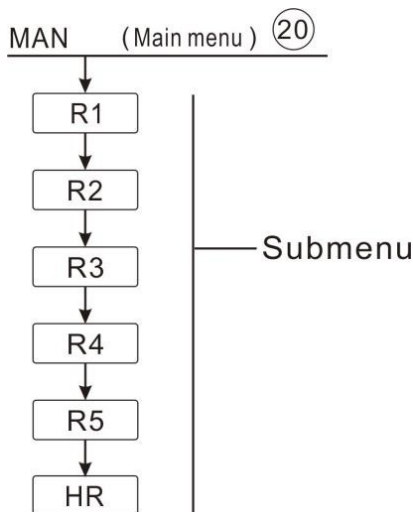

Main menu	Submenu	Default set	Adjust range	Description
MAN				Manual mode
	R1	OFF	ON/OFF	R1 On and OFF
	R2	OFF	ON/OFF	R2 On and OFF
	R3	OFF	ON/OFF	R3 On and OFF
	R4	OFF	ON/OFF	R4 On and OFF
	R5	OFF	ON/OFF	R5 On and OFF
	HR	OFF	ON/OFF	HR On and OFF

Function set:

- ▶ Press “SET” button to select menu “MAN”,
- ▶ Press “SET” button, “R1OFF” displays on the screen
- ▶ Press “SET” button, “OFF” blinks on the screen
- ▶ Press “↑”, “↓” button, to activate this function, “R1 ON” displays on the screen
- ▶ Press “SET” or “ESC” button, to confirm the setting
- ▶ Press “↑” button, “R2” displays, doing like above steps, to activate manual mode of relay R2, R3, R4, R5, HR



(21) BLPR Block protection function

Function description:

for protect the pumps against blocking after standstill, the controller is equipped with a blocking protection function. This function switches on the relays one after another every day at 12:00 a.m. and runs every relay for 10 s at 100 % speed.

Menu structure				
Main menu	Submenu	Default set	Adjust range	Description
BLPR				Block protection function
		OFF	ON/OFF	On and off this function

Functionset:

- ▶ Press “SET” button to select menu “BLPR”,
- ▶ Press “SET” button, “BLPR OFF” displays on the screen
- ▶ Press “SET” button, “OFF” blinks on the screen
- ▶ Press “↑”, “↓” button, to activate this function “BLPR ON” displays on the screen
- ▶ Press “SET” or “ESC” button, to confirm the setting



(22) OTDI Thermal disinfection function

Function description:

Thermal disinfection

Thermal disinfection function helps to prevent the spread of Legionella in DHW tanks by systematically activating the after-heating. One sensor and one relay can be selected for this function.

For thermal disinfection, the temperature at the allocated sensor should be monitored. During the monitoring period PDIS, this protection function ensures the temperature of tank exceeds continuously the pre-set disinfection temperature TDIS for the entire disinfection period DDIS., Thermal disinfection can only be completed when the disinfection temperature is exceeded for the duration of the disinfection period without any interruption.

The monitoring period PDIS starts as soon as the temperature at the allocated sensor falls below the disinfection temperature TDIS, once the monitoring period PDIS ends, disinfect period SDIS starts, the allocated reference relay activates the after-heating, and SDIS disinfect time count down “Disinfect 15” displays and flashes on the screen. If the temperature at the allocated sensor exceeds the disinfection temperature, thermal disinfection heating period DDIS starts, counts down time displays, count down time ends, thermal disinfection function stops.

Menu structure

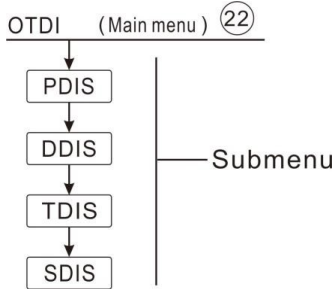

Main menu	Submenu	Default set	Adjust range	Description	Main menu
OTDI		OFF	ON/OFF		Disinfection function
	PDIS	7d	0-30d	1d	Disinfection monitoring time - section
	DDIS	10min	1-180	1min	Disinfection runtime
	TDIS	70°C	0-90°C	1°C	Disinfection temperature
	SDIS	18:00	00:00-21:00	1:00	Start time of disinfection

Function set:

▶ Press “SET” button to select menu “OTDI”,



▶ Press “SET” button, “OTDIOFF” displays on the screen

▶ Press “SET” button, “OFF” blinks on the screen

▶ Press “↑”, “↓” button, to activate this function “OTDI ON” displays on the screen



▶ Press “SET” or “ESC” button, to confirm the setting

▶ Press “↑” button, “PDIS 07” displays on the screen



▶ Press “SET” button, “07” blinks on the screen

▶ Press “↑”, “↓” button, to adjust monitor period of disinfection function (unit: day),

▶ Press “SET” or “ESC” button, to confirm the setting

▶ Press “↑” button, “DDIS 10Min” displays on the screen



▶ Press “SET” button, “10” blinks on the screen

▶ Press “↑”, “↓” button, to adjust disinfection heating time

▶ Press “SET” or “ESC” button, to confirm the setting

▶ Press “↑” button, “TDIS 70°C” displays on the screen



▶ Press “SET” button, “70°C” blinks on the screen

- ▶ Press “↑”, “↓” button, to adjust disinfection heating temperature
- ▶ Press “SET” or “ESC” button, to confirm the setting
- ▶ Press “↑” button, “SDIS18:00” displays on the screen
- ▶ Press “SET” button, hour “18” blinks on the screen
- ▶ Press “↑”, “↓” button, to adjust the start time of disinfection function
- ▶ Press “SET” or “ESC” button, to confirm the setting



(23) OPARR Parallel relay

According to the different selected system, the relay assigned to this function may be different

Function description:

With this function, e. g. a valve can be controlled in parallel to the pump via a separate relay. If solar loading takes place (R1 and / or R2) or if a solar function is active, the selected parallel relay will be energized too. The parallel relay can also energize the parallel pump inversely



Note:

- If R1 and / or R2 is in manual mode, then its parallel relay won't be energized.
- When  display on the screen, it means that the function is activated, if the icon flashes, it means that the function is running.
- INVE OFF means R1 triggered, parallel relay also triggered.
- INVE ON, means R1 ceased, parallel relay is switched-off

Menu structure

OPARR (Main menu) ②③

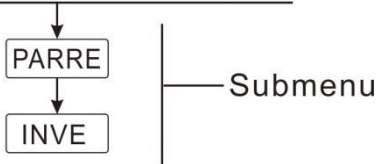

Main menu	Submenu	Default set	Adjust range	Description	Main menu
OPARR		OFF	ON/OFF		Parallel relay on/ off
	PARRE	R5	R2, R3, R4, R5		Selection a parallel relay (if one output is already used, then this output can't be selected)
	INVE	OFF	ON/OFF		Parallel relay logic on/off

Functionset:

▶ Press “SET” button to select menu “OPARR”,



▶ Press “SET” button, “OPARROFF” displays on the screen

▶ Press “SET” button, “OFF” blinks on the screen



▶ Press “↑”, “↓” button, to activate this function “OPARR ON” displays on the screen

▶ Press “SET” or “ESC” button, to confirm the setting



▶ Press “↑” button, “PARRE R5” displays on the screen

▶ Press “SET” button, “R5” blinks on the screen

▶ Press “↑”, “↓” button, to select parallel relay



▶ Press “SET” or “ESC” button, to confirm the setting

▶ Press “↑” button, “INVE OFF” displays on the screen

▶ Press “SET” button, “OFF” blinks on the screen

▶ Press “↑”, “↓” button, to activate this function, “INVE ON” displays on the screen



▶ Press “SET” or “ESC” button, to confirm the setting

(24) OHQMHeat quantity measurement

The heat quantity measurement can be carried out in 3 different ways:

- Fixed flow rate (with flow meter)
- With Grundfos flow sensor VFS.
- With rotary blade flow meter FRT



Note: picture of above mention flow meter see accessory paragraph 11

● **Heat quantity measurement with fixed flow rate value**

The heat quantity measurement calculation (estimation) uses the difference between the flow T7 and return T6 temperatures and the entered flow rate (at 100 % pump speed)



Note: in system with 2 solar circuit pumps, thermal energy measurement function is deactivated

- Under menu FTYP to set the flow rate type 1
- Read the flow rate (l/min) and enter this value in the **FMAX** menu into the control
- Adjust the antifreeze type and concentration of the heat transfer fluid under menu **MEDT**

and **MED%**.

Antifreeze liquid type:

- 0: Water
- 1: Propylene glycol
- 2: Ethylene glycol
- 3: Tyfocol LS / G-LS

● **Heat quantity measurement with Grundfos Direct Sensor VFS:**

The heat quantity measurement uses the temperature difference between flow sensor T7 and return sensor TVFS and the flow rate transmitted by the VFS sensor.

TVFS: Grundfos Direct sensor VFS

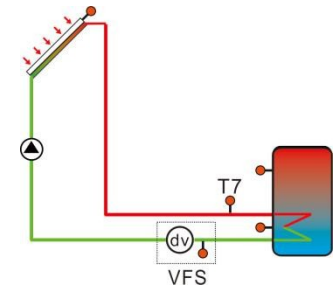

Note:

- Sensor of flow and return pipe for heat quantity measurement is default set in every system, it cannot be set.
- Flow checking function is only available when a VFS type Grundfos Direct Sensor is connected to the system.
- If Grundfos sensor VFS is select for calculating heat quantity, firstly you should activate VFS function under menu FS/GFDS, and select measurement range, default value is 1-12L/min.
- Under menu FTYP to set flow rate type 2 (VFS)
- Select the antifreeze type and concentration of the heat transfer fluid under menu **MEDT** and **MED%**.

T7: temperature sensor of flow pipe

TVFS: temperature sensor of return pipe

If VFS sensor is not corrected to be connected to the controller, icons  will blinks on the screen, temperature zone displays L/M - - -.

● **Heat quantity measurement with RotarybladeFlowMeterFRT**

- Under menu FTYP to set flow rate type 3 (FRT)
- The heat quantity measurement uses the temperature difference between flow sensor T7 and return sensor T6 and flow rate transmitted by the flow meter FRT
- Select the antifreeze type and concentration of the heat transfer fluid under menu **MEDT** and **MED%**.

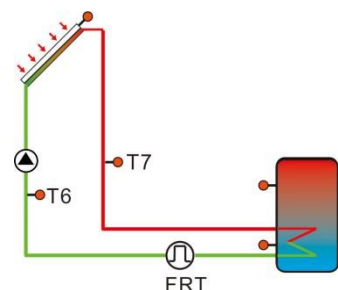

i **Note:** If Rotary blade flow Meter FRT is selected for calculating heat quantity, firstly you should activate FRT function under menu FS/FRT

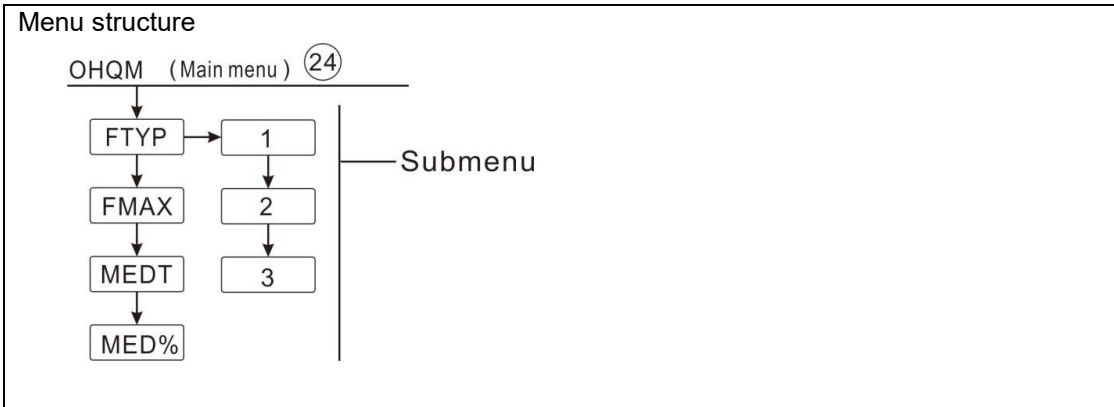

Main menu	Submenu 1	Submenu 2	Default set	Adjust range	Adjust step	Adjust range
OHQM			OFF	ON/OFF		Thermal energy measurement
	FTYP		1	1, 2, 3		Flow sensor selection 1: Fix flow value (glass tube flow meter) 2: Groundfos flow sensor VFS 3: Rotary blade flow meter FRT
	FMAX		6L/min	0.5-100L/min	0.1	Flowenter
	MEDT		3	0-3		Heattransfer Liquid 0: Water 1: Propylene glycol 2: Ethylene glycol 3: Tyfocol LS / G-LS
	MED%		45%	20-70%	1%	Concentration of the heat transfer fluid

Functionset:

- ▶ Press “SET” button to select menu “OHQM”,
- ▶ Press “SET” button, “OHQM OFF” displays on the screen
- ▶ Press “SET” button, “OFF” blinks on the screen
- ▶ Press “↑”, “↓” button, to activate this function “OHQM ON” displays on the screen
- ▶ Press “SET” or “ESC” button, to confirm the setting
- ▶ Press “↑” button, “FTYP 1” displays on the screen
- ▶ Press “SET” button, “1” blinks on the screen
- ▶ Press “↑”, “↓” button, to select type of flow meter (1,2,3)
- ▶ Press “SET” or “ESC” button, to confirm the setting



- ▶ Press “↑” button, “FMAX 6” displays on the screen
- ▶ Press “SET” button, “6” blinks on the screen
- ▶ Press “↑”, “↓” button, to adjust the flow rate value
- ▶ Press “SET” or “ESC” button, to confirm the setting
- ▶ Press “↑” button, “MEDT 3” displays on the screen
- ▶ Press “SET” button, “3” blinks on the screen
- ▶ Press “↑”, “↓” button, to select the type of heat transfer liquid
- ▶ Press “SET” or “ESC” button, to confirm the setting
- ▶ Press “↑” button, “MED% 45” displays on the screen
- ▶ Press “SET” button, “45” blinks on the screen
- ▶ Press “↑”, “↓” button, to adjust the concentration of the heat transfer fluid
- ▶ Press “SET” or “ESC” button, to confirm the setting





(25) FS Flow meter selection and flow monitor



Under this menu, the Grundfos direct sensor (VFS) and rotary blade flow meter (FRT) can be activated or deactivated, and its flow rate measurement range can be set also.

FLOW: Flow rate monitor function

Flow rate monitor (FLOW) is designed to detect the malfunctions which lead to a standstill of liquid flow, and as a reaction to shut down the corresponding tank. This will prevent system from damage, e. g. through a dry run of the pump.

If the allocated relay (R1) is energized, the flow rate will be monitored at the allocated sensor. After a delay detection time, an error message will appear when no flow rate is detected at the allocated sensor, icon   blink son the screen and temperature zone displays L/M0.0.

If the shutdown option has been activated for the flow rate monitoring function, the tank being loaded will be blocked for any further loading until the error message has been acknowledged. The next tank free for loading will be loaded instead, if possible. When the error message has been acknowledged, the monitoring function will be active again.

 **Note:** If the using Grundfos flow rate sensor VFS is removed, then icon  will blinks on the screen, and temperature zone displays L/M.

Menu structure

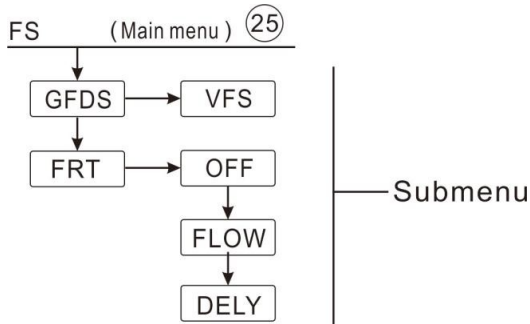

Main menu	Submenu 1	Submenu 2	Submenu 3	Default set	Adjust range	Adjust step	Description
FS							Register of flow sensor
	GFDS						
		VFS	OFF	OFF	OFF/ ON		Groundfos flow sensor
			1-12				Measurement range of flow meter (1-12L/min)
			2-40				Measurement range of flow meter (2-40L/min)
			FLOW	OFF	ON/OFF		Warning when no flow
			DELY	30s	1-600s	1s	Delay detect time when no flow
	FRT		OFF	OFF	OFF/ ON		Rotary blade flow meter
			FLOW	OFF	ON/OFF		Warning when no flow
			DELY	30s	1-600s	1s	Delay detect time when no flow

Functionset:

- ▶ Press “SET” button to select menu “FS”
- ▶ Press “SET” button, “GFDS” displays on the screen

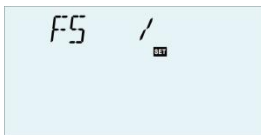

- ▶ Press “SET” button, “VFS OFF” displays on the screen
- ▶ Press “SET” button, “OFF” blinks on the screen
- ▶ Press “↑”, “↓” button, to activate this function “VFS 1-12V” displays on the screen

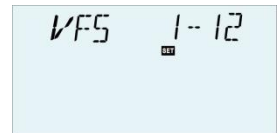

- ▶ Press “↑”, “↓” button, to adjust the measurement range of flow meter

- ▶ Press “SET” or “ESC” button, to confirm the setting
- ▶ Press “↑” button, “FLOW OFF” displays on the screen
- ▶ Press “SET” button, “OFF” blinks on the screen



- ▶ Press “↑”, “↓” button, to activate this function, “FLOW ON” displays on the screen

- ▶ Press “SET” or “ESC” button, to confirm the setting
- ▶ Press “↑” button, “DELY30” displays on the screen
- ▶ Press “SET” button, “30” blinks on the screen
- ▶ Press “↑”, “↓” button, to adjust the delay detect time when no flow
- ▶ Press “SET” or “ESC” button, to confirm the setting
- ▶ Press “ESC” button to return to previous menu
- ▶ Press “↑” button, “FRT” displays on the screen
- ▶ Press “SET” button, “FRT OFF” displays on the screen
- ▶ Press “SET” button, “OFF” blinks on the screen
- ▶ Press “↑”, “↓” button, to activate this function, “FRT ON” displays on the screen
- ▶ Press “SET” or “ESC” button, to confirm the setting
- ▶ Press “↑” button, “FRT” displays on the screen
- ▶ Press “SET” button, “FLOW OFF” displays on the screen, same process as above step



(26) UNIT Unit switch

Under this menu, below unit can be set:

TEMP: temperature

ENEG: heat quantity, 1: KWH, 2: BTU

The units can be switched during operation.

Menu Structure				
<pre> graph TD UNIT["UNIT (Main menu) (26)"] --> TEMP["TEMP"] UNIT --> ENEG["ENEG"] TEMP --> ENEG </pre>				
Main menu	Submenu	Default set	Adjust range	Description
UNIT				Unit Switch
	TEMP	°C	°C/°F	°C-°F Switch
	ENEG	1(Wh)	1(Wh) /2(BTU)	Energy unit switch

Functionset:

- ▶ Press “SET” button to select menu “UNIT”



- ▶ Press “SET” button, “TEMP°C” displays on the screen
- ▶ Press “SET” button, “°C” blinks on the screen
- ▶ Press “↑”, “↓” button, to select temperature unit
- ▶ Press “SET” or “ESC” button, to confirm the setting
- ▶ Press “↑” button, “ENEG 1” displays on the screen
- ▶ Press “SET” button, “1” blinks on the screen
- ▶ Press “↑”, “↓” button, to select thermal energy unit
- ▶ Press “SET” or “ESC” button, to confirm the setting



(27) OSDC (SD card)



This controller is equipped with a card slot for the MicroSD memory card. With this MicroSD card, following functions can be carried out:

- Logging measurement and balance values. After transferring the card to a computer, the values can be opened and visualized, e. g. in a spreadsheet.
- Copy and parameters recovery: make a copy of all parameters on the MicroSD card, if necessary, it is possible to recover data from SD card to the firmware of controller.
- Insert SDcard, a card icon appears on the screen, if card is full, warning signal appears and word remind can be found on the check interface.

● **Update firmware of the controller.**

The current firmware software can be updated. Doing like follow steps:

- Firstly switch-off the power of controller
- Insert the MicroSD card with an updated firmware program into controller
- Hold down the holiday button “” and switch-on the power supply to controller

- An update inquiry appears on the screen, and Press “SET” button to confirm
- Then, controller starts firmware update automatically
- After update, following the indication press “SET” button and controller is rebooted and return to the main interface.
- If it is needed to override the update process, please press “ESC” button, controller will recover to the normal interface.
- If there is any wrong operation, just reopen the controller and repeat above steps.



Note:The controller will only search the file named "SR658.bin"(firmware update program)on the root directory of MicroSD memory card. detailed update steps, see paragraph 8.

- **Data logging**

Insert the MicroSD card into the slot of controller, Logging will start immediately.

- **Data logging frequency on the SD card (LOGI)**

Under menu OSD/LOGI to set the data logging frequency

- **Completing data logging process (REMC)**

Select menu REMC, “YES” displays on the screen, press “SET”, cursor will move to the “YES”, and press “SET” continuously, extract card order runs, after running, “SUCC” appears on the screen, then SD card can be taken out from the controller.

- **Formatting the MicroSD card (FORM)**

Select the menu FMTSD, “YES” displays, press “SET” to move the cursor to “YES”, press “SET” continuously until “WAIT” displays, card formatting order starts to run, it lasts ca. 10 seconds, after formatting, “SUCC” will displays, the content of the card will be deleted and card will be formatted with the FAT file system.

- **Saving the parameter set on SD card(SAVE)**

Select the menu SAVE to save the controller parameters on the MicroSD card.

Select the menu SAVE, “YES” displays, press “SET” to move the cursor to “YES”, press “SET” to run save order, after saving, “SUCC” will displays.

The controller parameters are save in a file named “SR658.DAT”.

● **Uploading controller parameters (LOAD)**

Upload controller parameter from SD card to the controller, controller parameters are saved in the file named “SR658.DAT” on SD card, select menu “LOAD”, “YES” displays, press “SET” to move the cursor to “YES”, press “SET” continuously to run file loading, and then “SUCC” will be indicated on the display.

i **Note:**this controller supports the MicroSD with maximum size of 32G, under OSD menu, if “SAVE”、“LOAD”、“REMC”、“FMTSD” functions run successfully, behind every menu, “SUCC” displays, then you can no longer run these functions, but you can exit this menu and reenter, then such functions can be reactivated.

(28) RET Reset

RSTP (menu parameters): by reset function, all setting can be recovered to the factory default value.

CHQM (accumulated energy): Accumulated heat can be reset to 0

CPT (accumulated pump running time):Accumulated pump running time(R1time / R2time/ R3time)can be reset to 0

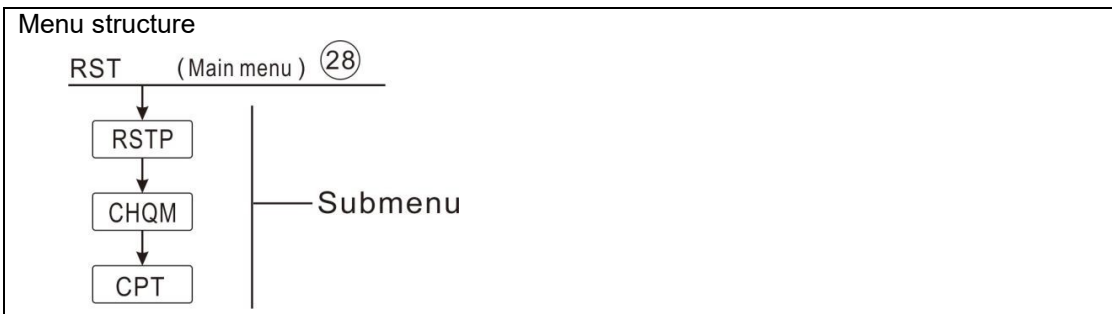

Functionset:

- ▶ Press “SET” button to select menu “RST”
- ▶ Press “SET” button, “RSTP” displays on the screen
- ▶ Press “SET” button, “YES” blinks on the screen
- ▶ Press “SET” button for 3 seconds, beeper sounds “di, di, di” remind, and “YES” remains lighting, it indicates system is recovered to the factory set.
- ▶ Press “ESC” button return to the submenu
- ▶ Press “↑” button, “CHQM” displays on the screen, same steps like above, to reset CHQM, CPT parameters.



(29) PASS Password set

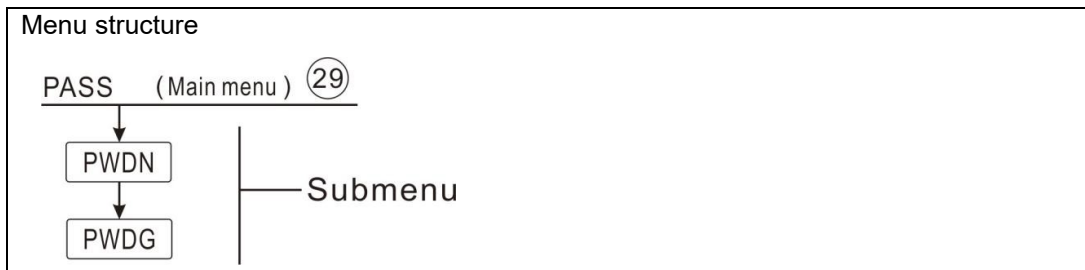

Functionset:

- ▶ Press “SET” button to select menu “PASS”
- ▶ Press “SET” button, “PWDN 0000” displays on the screen
- ▶ Press “SET” button, the left digital blinks, ask for a new password
- ▶ Press “↑”, “↓” button, to enter the first digital
- ▶ Press “SET” button, the second digital blinks
- ▶ Press “↑”, “↓” button, to enter the second digital
- ▶ Press “SET” button, the third digital blinks
- ▶ Press “↑”, “↓” button, to enter the third digital
- ▶ Press “SET” button, the forth digital blinks
- ▶ Press “↑”, “↓” button, to enter the forth digital
- ▶ Press “SET” button, “PWDG 0000” displays, press “SET” to enter password again. Doing like above steps to enter new password and confirm, then “OK” displays on the screen. It indicates new password is set successfully.

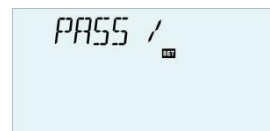

i Note: If the password is forgot, it is impossible to recover, but you can recover the password to factory set, then you can reedit a password like above descript steps, doing like following to recover to factory set.

- ▶ Switch-off the power to controller
- ▶ Hold down “ESC” button
- ▶ Reconnect the power supply, beeper sounds “di, di, di” remind, and then release “ESC” button, password is recovered to the factory set, (factory set password is 0000),

8. Holiday function

Function description:



The holiday function is designed to run the system when no water consumption is expected, e. g. during a holiday absence. This function will cool down the system to reduce the thermal load.

2 cooling functions are available: tank cooling (OSTC) and tank heat transfer (OHDP).



Note: Controller is designed to run tank heat transfer (OHDP) function priority, when tank heat transfer (OHDP) function is deactivated, then tank cooling function (OSTC) runs automatically in turn.

Activated / deactivate holiday function

- ▶ Press “” button for 3 seconds, “HDAY 05” displays.
- ▶ Press “↑”, “↓” button to adjust days of holiday, adjustable range 0-99 days.
- ▶ Press “SET” or “ESC” button, to confirm the setting
- ▶ Press “” button again to deactivate holiday function



Note: this function is only activated when you are not at home for a longer time, when you return from holiday, please deactivate this function in time.

9. Software of controller update

- 1) Please copy the file (SR658.bin) to the root directory of Micro SD Card. See screen snap below.

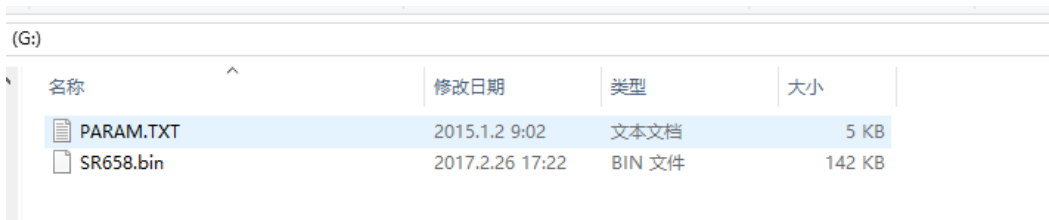

- 2) Switch-off the power and insert card to the controller, then hold down button “”, and reconnect power to controller. Then the screen will show “BOOT 1.0”

If card and file both are ok, then indication “UPD YES” appears, and “YES” blinks, press “SET” to continue the update, and “MANL UPD” shows, or press “ESC” to exit firmware update and return to the normal interface.

If card and file has problem, there is remind either “INPUT CARD” or “INVLD FILE” on the screen, please follow the attached FAQ to do further steps.

Update process running ca. 3 seconds, then “UPD SUCC”

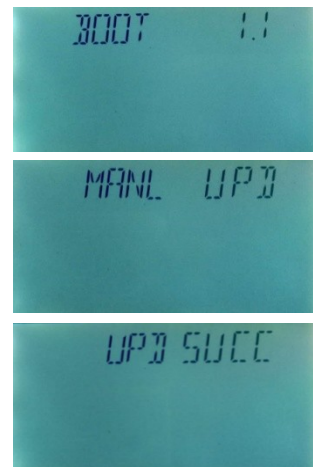

indicated on the screen, it means software is succeeded to be updated. Then press “SET” or “ESC”, controller returns to the normal system.

3) After access the normal system interface, please make sure the software version is OK.

i Note: during the update process, please don't switch-off the power to the controller

FAQs:

String on screen	Reason
BOOT x.x	Display boot loading information for a while
INPUT CARD	No Micro SD card
INVLD FILE	Please check the file in card, update the file, and try again. make sure the format of the card is FAT.
UPD YES	Blue font flash. Have firmware to upgrade in Micro SD card, press “SET” key to start
AUTO UPD	Auto upgrading firmware
MANL UPD	Manual upgrading firmware
UPD SUCC	Upgrade successfully
UPD FAIL	Upgrade failed.

10. Protection function

10.1 Screen protection

When no any press on button for 5 minutes, screen protection is activated automatically, and then LED background lamp is switched-off. Through press any button to light LED lamp again.

10.2 Trouble protection

When there is a break or short circuit between the connection of temperature sensors, flow meter, controller switches off the corresponding functions and no more output signals are given, at the same time error signal  appears on the screen and indication lamp flashes.

▶ Press “↑”“↓” button to view the error message (red indication)

i Note: if there are sensor faults or setup errors, the indication code and errors of sensors displays alternately.

1. Target tank sensor THS for timing heating function
2. Sensor for tank maximum temperature limitation SMAX
3. Sensor for thermostat function AHS
4. Tank sensor for heating circuit return pipe heated function TANK

10.3 Trouble checking

The built-in controller is a qualified product, which is conceived for years of continuous

trouble-free operation. If a problem occurs, the most of causes is from the peripheral components but no relation with controller itself. The following description of some well-known problems should help the installer and operator to isolate the problem, so that the system can be put into operation as quickly as possible and to avoid unnecessary cost. Of course, not all possible problems can be listed here. However, most of the normal problems encountered with the controller can be found in the list below, only return the controller to seller when you are sure that none of the problems listed below is responsible for the fault.

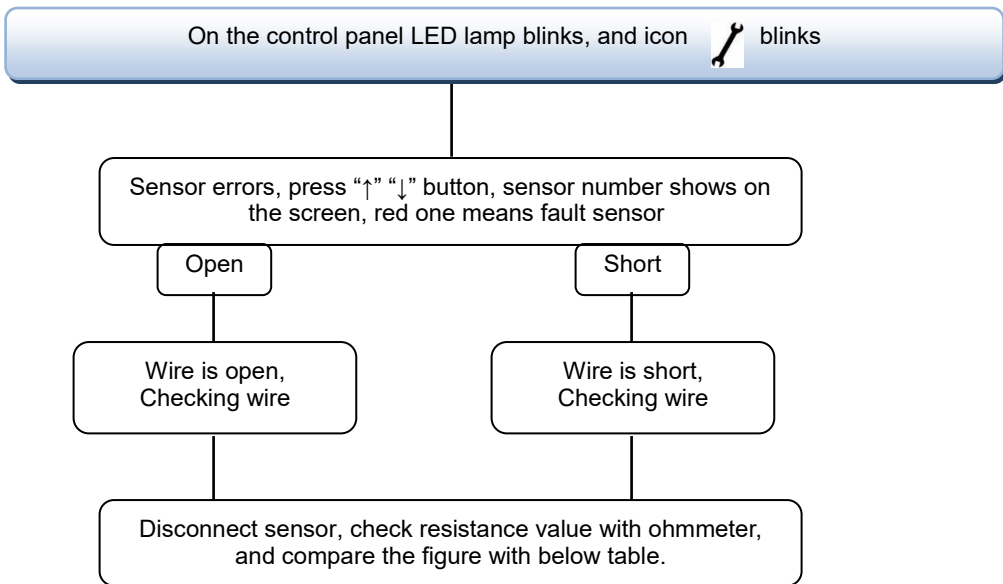

PT1000 resistance value

℃	0	10	20	30	40	50	60	70	80	90	100	110	120
Ω	1000	1039	1077	1116	1155	1194	1232	1270	1309	1347	1385	1422	1460

NTC 10K B=3950 resistance value

℃	0	10	20	30	40	50	60	70	80	90	100	110	120
Ω	33620	20174	12535	8037	5301	3588	2486	1759	1270	933	697	529	407

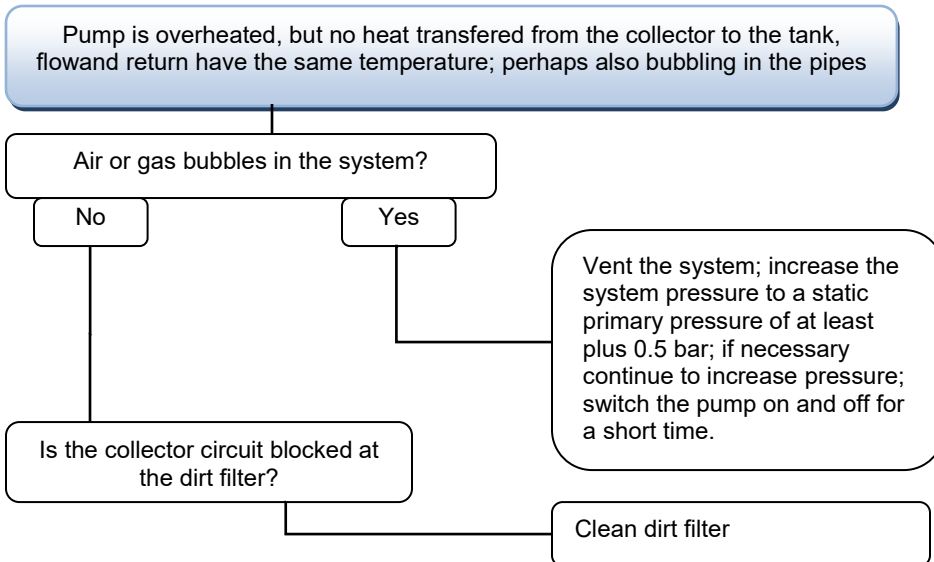
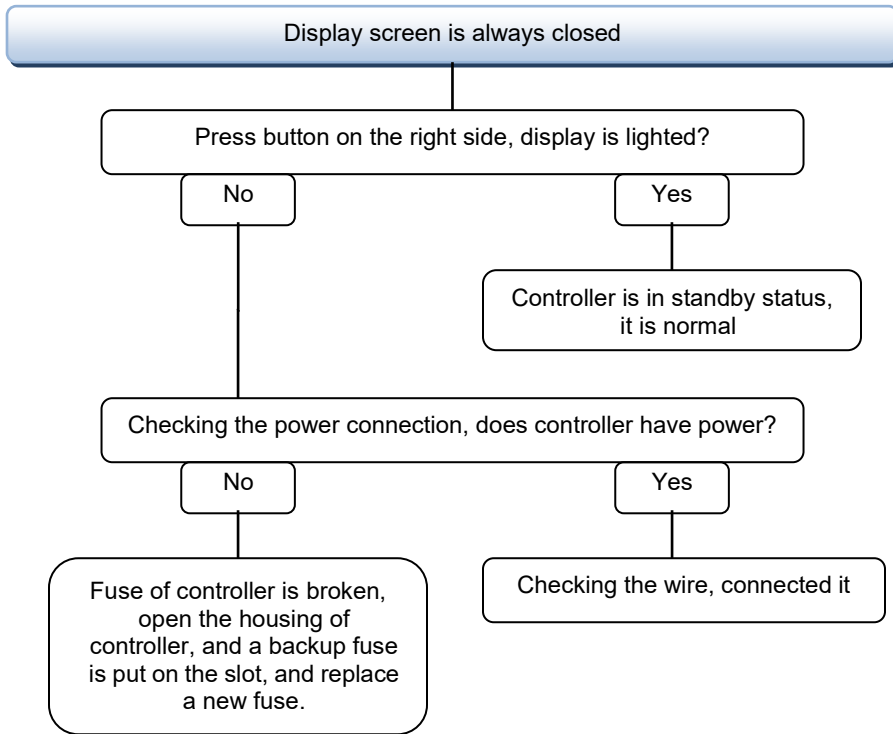

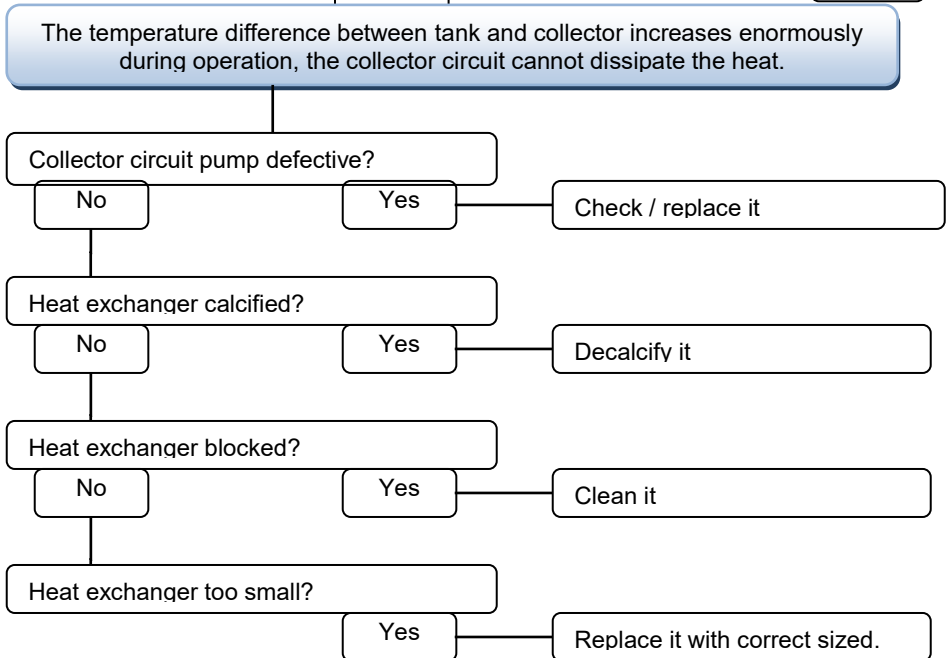
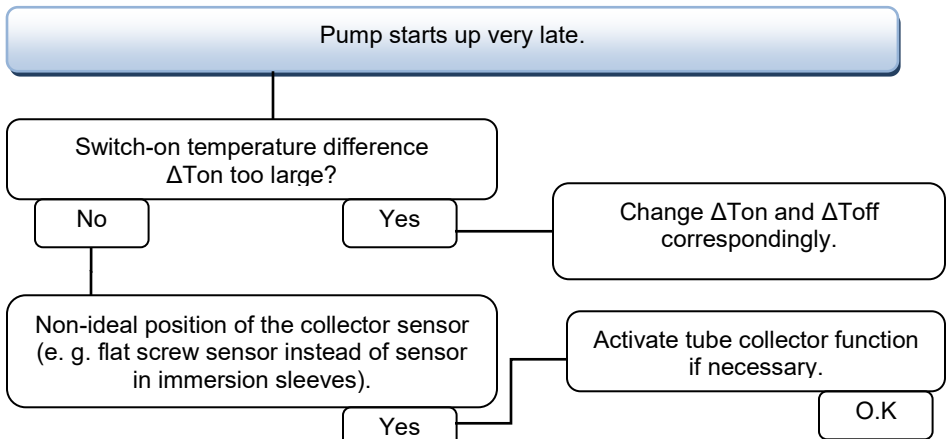
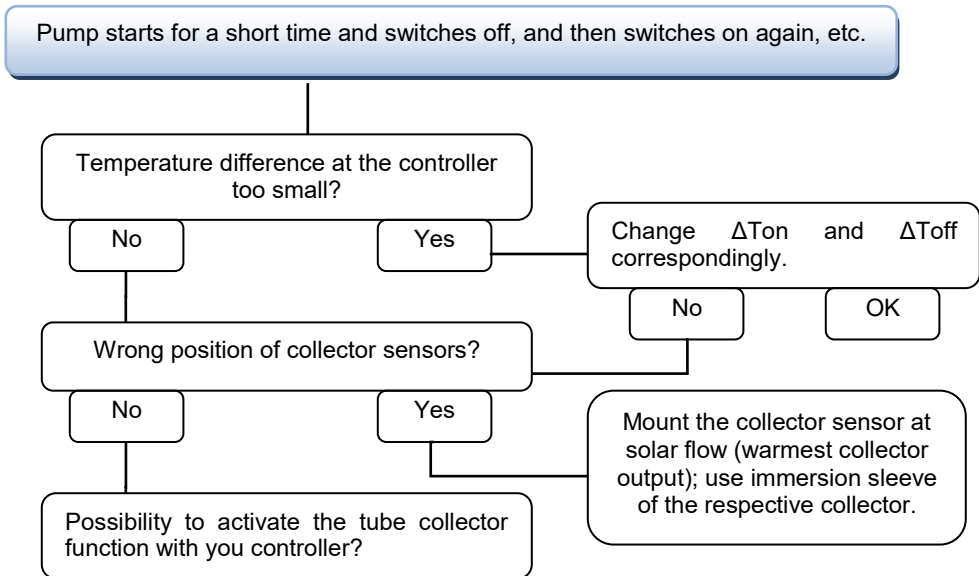

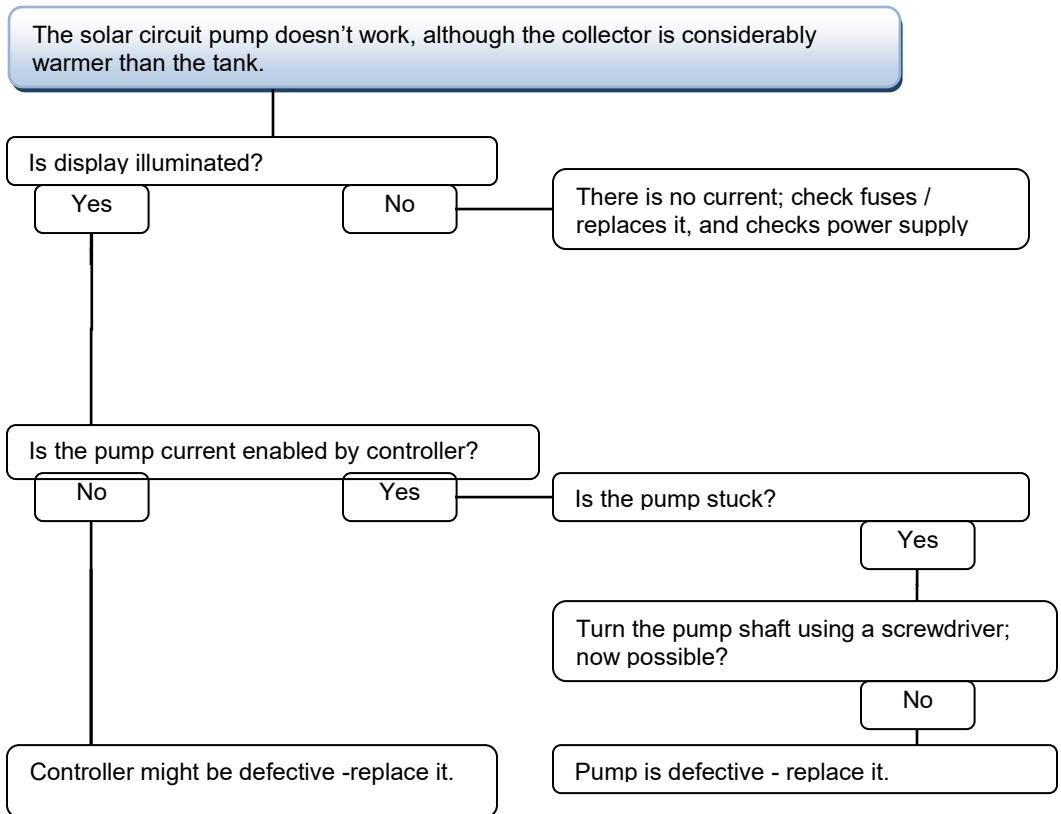

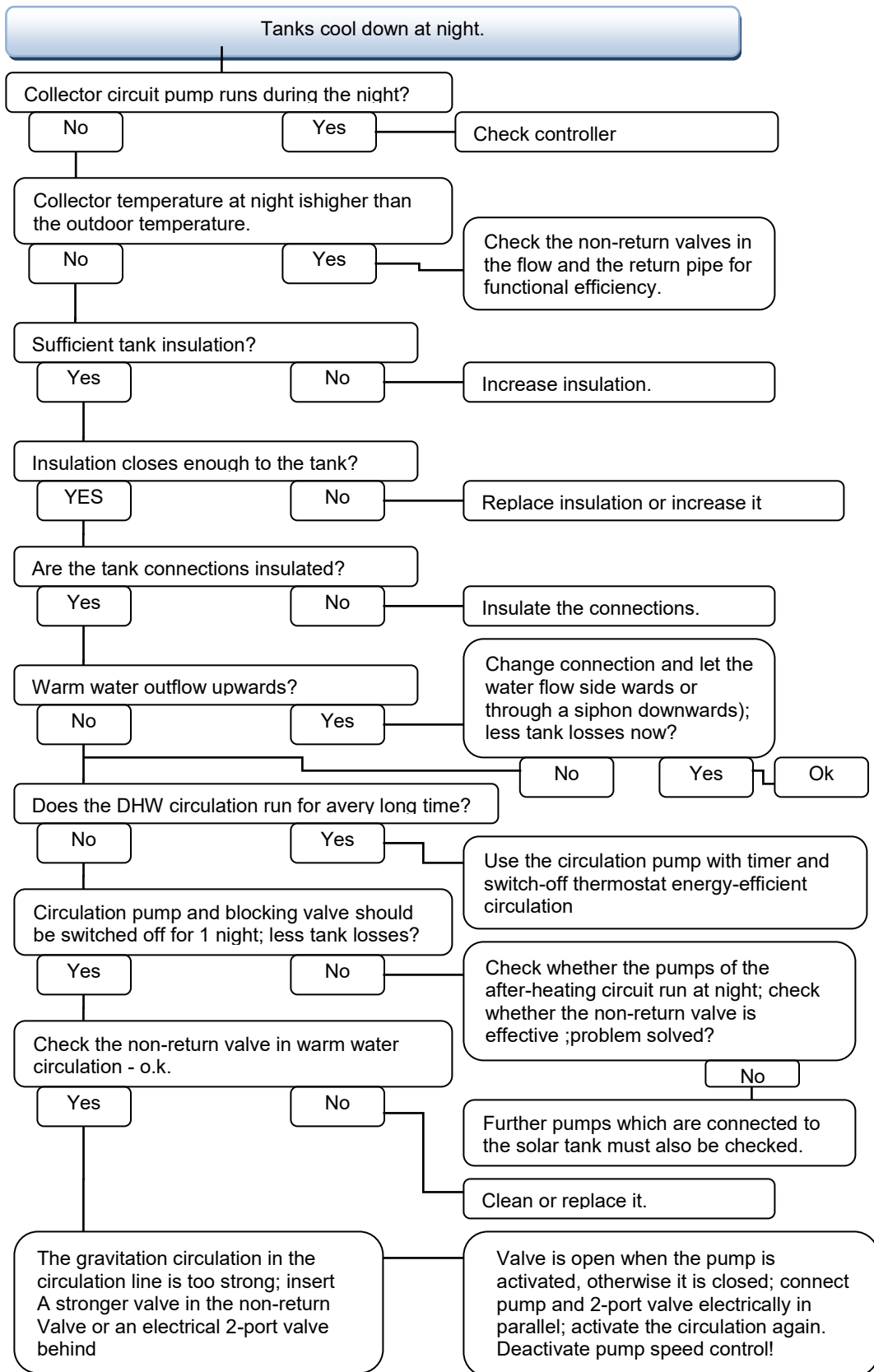







11. Quality Guarantee

Manufacturer provides following quality responsibilities to end-users: within the period of quality responsibilities, manufacturer will exclude the failure caused by production and material selection. A correct installation will not lead to failure. When a user takes incorrect handling way, incorrect installation, improper or crude handling, and wrong connection of Warm water outflow upwards?

The quality warranty expires within 24 months after the date of purchasing the controller.

12. Accessories

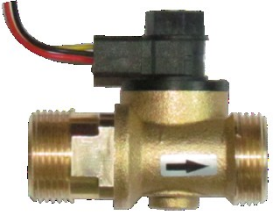
Products name	Specification	Products picture
A01: High accurate Pt1000 sensor for collector	PT1000, $\Phi 6 \times 50\text{mm}$, with 1.5m cable	
A02 High accurate sensor for tank and pipe	NTC10K, B=3950, $\Phi 6 \times 50\text{mm}$, with 3m cable	
A05 304 stainless steel thermo well	304 stainless steel with thread 1/2' OT, Size: $\Phi 8 \times 200$	
A13 Groundfos Direct Sensor VFS	1-12l/min 2-40l/min	
Mechanical flow meter	Germany Affisso Parameter: DFM 15-2M G3/4 Flow range: 2-12L/min	

<p>FRT electronic flow meater</p>	<p>Connector: M thread 3/4 Power: 5-24V/DC</p>	
<p>SR-43W flow switch</p>	<p>Material: Brass House: Plastic Connector: G3/4 Reed: Max 300V DC/1A</p>	
<p>SR802 Unit for high power electrical heater</p>	<p>Dimension: 100mm*100mm*65mm Power supply: AC180V ~ 264V, 50/60Hz Suitable power: ≤ 4000W Available ambient temperature: -10 ~ 50°C Waterproof grade: IP43</p>	

● **SR802 connection diagram**

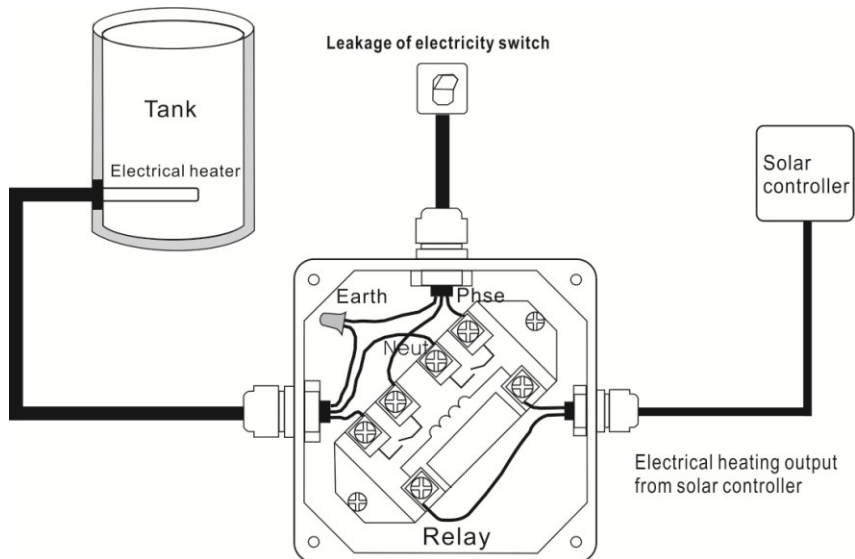

Note: Switch-off power, and perform by profession installer.